

ICOM

PROGRAMMING
MANUAL

<http://www.qsl.net/pe3hmp>

IC-V210T
IC-H21T

Code 2751

3116 (H21)

FOREWORD

This manual explains in detail how to use and program each of the available functions in the **IC-V210T** and **IC-H21T VHF TRANSCEIVERS**. If you have a **MASTER** transceiver for clone programming in your Service Center, it is not necessary to program each transceiver in stock.

About half of the data in these transceivers can be programmed without external programming equipment. With an **EX-704 DATA PROGRAMMER** ver 1.0 or 2.0 plus an **EX-1033 EXPANSION ROM BOARD** (known as an **EX-704** ver. 3.0), you can modify and clone almost all data in these transceivers according to customers' requirements.

TABLE OF CONTENTS

FOREWORD	i
TABLE OF CONTENTS	i
1. GENERAL DESCRIPTION	1
1-1 Mode construction	1
1-2 Channel description	1
2. CLONING AND DIRECT PROGRAMMING ..	2 ~ 4
2-1 Cloning form the master transceiver	2
2-2 Direct programming	3
3. DATA PROGRAMMING	5 ~ 6
3-1 Common data	5
3-2 Memory channel data	5
3-3 TX 5-tone channel data	6
3-4 RX 5-tone channel data	6
3-5 Answer back channel data	6
3-6 Channel combining	6
4. OPERATING INSTRUCTIONS	7 ~ 16
4-1 Operating chart	7
4-2 Mark description	7
4-3 Receiving	8
4-4 Transmitting	12
4-5 Other functions	15
5. SET MODE CHART	17
6. SET MODE 1	18 ~ 24
■ Memory channel number	18
■ RX frequency	18
■ TX shift	19
■ RX tone	19
■ TX tone	20
■ Receive number selection	20
■ Long tone	21
■ Repeater code	21
■ TX inhibit	22
■ Scan channel	22
■ Repeater lockout	23
■ Reset switch	23
■ Hanger switch (IC-V210T only)	24
7. SET MODE 2	25 ~ 26
■ TX 5-tone channel number	25
■ TX 5-tone code	25
■ Comment	26
■ ABC decode	26
8. SET MODE 3	27 ~ 28
■ Display mode	27
■ Beep ON/OFF	27
■ Auto reset	28
9. SET MODE 4	29 ~ 30
■ RX 5-tone channel number	29
■ RX 5-tone code	29
■ Status digit	30
10. SET MODE 5	31 ~ 32
■ Answer back code 1	31
■ Answer back code 2	31
■ Answer back code 3	32
11. APPENDIX	33 ~ 37
11-1 IC-V210T installation and connections	33
11-2 IC-V210T panel description	34
11-3 IC-H21T panel description	35
11-4 Specifications	36
11-5 Options	36
11-6 Data in the transceivers	37

1-1 Mode construction

The IC-V210T and IC-H21T have 2 major modes. OPERATING mode and PROGRAMMING mode.

OPERATING MODE

This mode is used for normal transmitting and receiving.

PROGRAMMING MODE

This mode consists of 2 programming methods as follows:

- Cloning from the master transceiver
- Direct programming in SET mode

There are 2 types of SET mode. user SET mode and dealer SET mode. In the transceiver for direct programming.

Dealer SET mode and CLONING mode can program the functions of each channel such as operating frequency, 5-tone code, CTCSS tone, etc. User SET mode can program only some of these functions. See Section 2 for details.

1-2 Channel description

The IC-V210T and IC-H21T have 4 types of channels.

- Memory channels
- TX 5-tone channels
- RX 5-tone channels
- Answer back channels

See Section 3 for channel programming details.

MEMORY CHANNEL

100 memory channels are provided on each transceiver. Each memory channel contains all of the following data:

1. RX frequency
2. RX tone
3. TX shift
4. TX tone
5. Repeater code
6. Format
7. Scan channel (Lockout)
8. TX inhibit
9. Low power
10. T.O.T. (Time-Out Timer)
11. Repeater lockout
12. TX 5-tone channel
13. Reset switch
14. Hanger switch (IC-V210T only)
15. Channel mute operation
16. Log IN/OFF
17. Long tone repeater
18. Long tone call
19. Long tone ID
20. Link tone repeater
21. Link tone call
22. Link tone ID
23. Receive number selection
24. Duration time

TX 5-TONE CHANNEL

Each transceiver has 30 TX 5-tone channels. Tch 00 ~ Tch 29.

Each TX 5-tone channel contains all of the following data:

1. TX 5-tone code
2. ID out
3. ABC decode
4. Comment
5. Answer back display

RX 5-TONE CHANNEL

Each transceiver has 4 RX 5-tone channels. Rch 1 ~ Rch 4.

Each RX 5-tone channel contains all of the following data:

1. RX 5-tone code
2. ABC out
3. Bell display
4. Beep out
5. EXC out
6. Auto scan
7. ID decode
8. Decode action
9. Auto TX
10. Status digit
11. ID (Rch 1 only)

NOTE: Each transceiver also has a group code channel (Rch G). The data of Rch G is used for transceiver performances when the transceiver is called by a group code. All data of Rch G cannot be programmed, but can be cloned from the EX-704 version 3.0.

ANSWER BACK CHANNEL

Each transceiver has 3 answer back channels: ABch 1, ABch 2, and ABch 3. Each one contains different answer back data.

There are 2 programming methods:

- Cloning from the master transceiver
- Direct programming

2-1 Cloning from the master transceiver

When you have a master transceiver, cloning is the easiest way to program. This method programs transceivers to contain completely the same data as the master transceiver.

When programming a transceiver to contain most, but not all, of the data of the master transceiver, perform cloning then modify the data by direct programming.

NOTE: Clonings from the IC-V210T to the IC-H21T and vice versa are impossible. Attempts at cloning may destroy data.

(1) Presetting

Connect a slave transceiver to the master transceiver as shown in the diagram below.

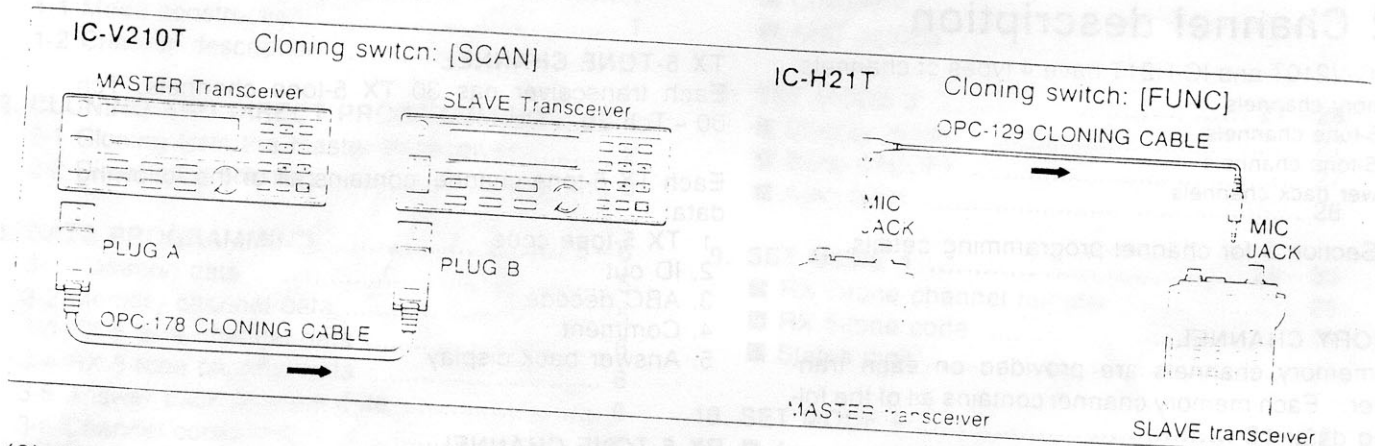

(2) Operation

- 1) Turn OFF the power of both transceivers.
- 2) Check the cloning cable connection between the master transceiver and the slave transceiver.
- 3) On the master transceiver, while pushing and holding [SCAN] or [FUNC], turn ON the power. And, hold [SCAN] or [FUNC] until a beep sounds.
- 4) Release [SCAN] or [FUNC] of the master transceiver.
 - "CLONE RX" appears and a beep sounds again.
 - The master transceiver is in the cloning condition.
- 5) On the slave transceiver, while pushing and holding [SCAN] or [FUNC], turn ON the power. And, hold [SCAN] or [FUNC] until a beep sounds.
- 6) Release [SCAN] or [FUNC] of the slave transceiver.
 - "CLONE RX" appears and a beep sounds again.
 - The slave transceiver is in the cloning condition.
- 7) On the master transceiver, push [SCAN] or [FUNC].
 - "CLONE RX" changes to "CLONE TX."
 - Data sending starts.
- 8) When cloning finishes, a beep sounds.
 - Both transceivers enter OPERATING mode.
 - When data is sent incorrectly, "ERROR" appears. See the box below when "ERROR" appears.

WHEN "ERROR" APPEARS

- 1) Turn OFF the power of both transceivers.
- 2) Check the cloning cable's direction and connection condition. Then reconnect the cable.
- 3) Begin the cloning procedure again.

2-2 Direct programming

(1) SET mode description

The IC-V210T and IC-H21T offer the following 2 SET modes.

- User SET mode
- Dealer SET mode

USER SET MODE

Users can enter this mode freely.

SET mode 1 ~ 4 can be used and up to 9 items are programmed in this mode.

NOTE: Programmable items can be restricted by cloning from the EX-704 version 3.0. See the EX-704 version 3.0 programming manual for details.

DEALER SET MODE

Only dealers who know the dealer passcode can enter this mode.

SET mode 1 ~ 5 can be used and all 26 items are programmed in this mode.

NOTE: All data in SET mode can be programmed in dealer SET mode.

(2) Accessing the SET mode condition

After the transceiver has entered this condition once, SET mode can be selected anytime until the power is turned OFF. (See instructions below.)

To cancel the SET mode condition, turn OFF power and turn ON power again.

Step 1

USER SET MODE

- 1) Turn OFF power.
- 2) While pushing [SET], turn ON power.
 - Long beep is emitted.
- 3) Release [SET].
 - "PASSWORD" appears when the password has been programmed.
- 4) Enter the password from the keyboard.
- 5) "SET MODE" appears, and then the transceiver automatically enters OPERATING mode.
 - Now the transceiver is in the user SET mode condition.

DEALER SET MODE

- 1) Turn OFF power.
- IC-V210T:**
- 2) While pushing [SET] and [RESET], turn ON power.
 - Long beep is emitted.
- IC-H21T:**
- 2) While pushing and holding [SET] and [LIGHT], turn ON power.
 - Long beep is emitted.
 - 3) Release the switches.
 - "PASSCODE" appears.
 - 4) Enter the dealer passcode from the keyboard.
 - 5) "DEALER" appears, and then the transceiver automatically enters OPERATING mode.
 - Now the transceiver is in the dealer SET mode condition.

Step 2 set mode I

(3) Entering SET mode

- 1) Be sure the transceiver is in the SET mode condition. (p.3)
- 2) Push [SET] then push the desired SET mode number (1 ~ 5). When the operating channel number appears on the left side of the function display.

See Sections 6 ~ 10 to program each function.

When the transceiver is in the SET mode.

- The PTT and [CALL] switches cannot be used.
- Transceiver can receive signals, but 5-tone codes cannot be decoded.

Don't set 24 Day Tone

WHEN ENTERING SET MODE 1 FROM THE USER SET MODE CONDITION.

When entering SET mode 1 from the user SET mode condition, you MUST select a memory channel number to be programmed before entering since you cannot access "Memory channel number" in the user SET mode. Moreover, changing the memory channel number to be programmed is NOT possible, once the transceiver has entered SET mode 1.

if you change the memory channel number to be programmed in SET mode 1, exit SET mode 1 and select the memory channel number, then enter SET mode 1 again.

FUNCTIONS	DEALER SET MODE	USER SET MODE	CLONING FROM A MASTER TRANSCEIVER
SET MODE 1 (Memory channel data)			
1 Memory channel number	•	-	•
2 RX frequency	•	-	•
3 TX shift	•	-	•
4 RX tone	•	-	•
5 TX tone	•	-	•
6 Receive number selection	•	•	•
7 Long tone	•	-	•
8 Repeater code	•	-	•
9 TX inhibit	•	-	•
10 Scan channel (Lockout)	•	•	•
11 Repeater lockout	•	-	•
12 Reset switch	•	-	•
13 Hanger switch (IC-V210T only)	•	-	•
SET MODE 2 (TX 5-tone channel data)			
1 TX 5-tone channel number	•	•	•
2 TX 5-tone code	•	•	•
3 Comment	•	•	•
4 ABC decode	•	-	•
SET MODE 3 (Common data)			
1 Display mode	•	•	-
2 Beep ON/OFF	•	•	-
3 Auto reset	•	-	-
SET MODE 4 (RX 5-tone channel data)			
1 RX 5-tone channel number	•	•	•
2 RX 5-tone code	•	•	•
3 Status digit	•	-	•
SET MODE 5 (Answer back channel data)			
1 Answer back channel 1 tone code	•	-	•
2 Answer back channel 2 tone code	•	-	•
3 Answer back channel 3 tone code	•	-	•

- Applicable
- Not applicable

NOTE: The functions to be programmed in user SET modes can be restricted by cloning from the EX-704 version 3.0.

3-1 Common data

- 1) Enter dealer SET mode condition.
• [RESET] or [LIGHT] and [SET] + Power ON. (p. 3)
- 2) Enter SET mode 3.
• [SET] then [3]. (p. 4)
- 3) Program the contents which you need to change.
- 4) To exit SET mode 3, push [RESET].

REFERENCE

The other 29 common data described at right can be programmed using the EX-704 DATA PROGRAMMER version 3.0.

- IF frequency
- IF frequency (-) sign
- Power saver (IC-H21T)
- Scan mode
- 10key select
- T.C.T. alarm
- Call action
- Scan at power ON
- Monitor at power ON
- Digit to indicate
- Digit to change
- Digit to decode
- User password
- Dealer passcode
- Time-out timer
- Power saver OFF timer (IC-H21T)
- Power saver ON timer (IC-H21T)
- Fast scan timer
- Slow scan timer
- Resume scan timer
- Burst timer
- TX mute timer
- RX mute timer
- Penalty timer
- EXC timer (IC-V210T)
- Auto reset timer
- Link1 time
- Link2 time
- Link3 time
- Long tone time
- Wait time ID
- Wait time ABC

3-2 Memory channel data

Each memory channel (0 ~ 99) can be programmed as a CTCSS memory channel, as a 5-tone memory channel, or as a 5-tone + CTCSS memory channel.

- 1) Enter dealer SET mode condition.
• [RESET] or [LIGHT] and [SET] + Power ON. (p. 3)
- 2) Enter SET mode 1.
• [SET] then [1]. (p. 4)

- 3) Select the memory channel number to be programmed. (p. 18)
- 4) Decide if the memory channel will be programmed as a CTCSS memory channel, as a 5-tone memory channel, or as a 5-tone + CTCSS memory channel.
- 5) See the boxes below for the list of required contents for each type of memory channel. Contents not listed (e.g. Nos. 6, 7, 8 in CTCSS) should not be programmed.

CTCSS MEMORY CHANNEL

- 1 Memory channel number
- 2 RX frequency
- 3 Offset frequency
- 4 RX tone
- 5 TX tone
- 6
- 7
- 8
- 9 TX inhibit
- 10 Scan channel
- 11 Repeater lockout
- 12 Reset switch
- 13 Hanger switch (IC-V210T only)

5-TONE MEMORY CHANNEL

- 1 Memory channel number
- 2 RX frequency
- 3 Offset frequency
- 4
- 5 Receive number selection
- 7 Long tone
- 8 Repeater code
- 9 TX inhibit
- 10 Scan channel
- 11
- 12 Reset switch

5-TONE + CTCSS MEMORY CHANNEL

- 1 Memory channel number
- 2 RX frequency
- 3 Offset frequency
- 4 RX tone (For mute in scanning)
- 5 TX tone (For repeater access)
- 6 Receive number selection
- 7 Long tone
- 8 Repeater code
- 9 TX inhibit
- 10 Scan channel
- 11
- 12 Reset switch

- 6) Select the other channels to be programmed, and proceed to steps 4 and 5.

- 7) To exit SET mode 1, push [RESET].

REFERENCE

The other 10 functions described at right can be programmed in each memory channel using the EX-704 DATA PROGRAMMER version 3.0.

- 5-tone system format
- Low power
- T.O.T.
- Corresponding TX 5-tone code
- Channel mute operation
- Log IN/OFF
- Link tone repeater
- Link tone call
- Link tone ID
- Duration time

3-3 TX 5-tone channel data

- 1) Enter dealer SET mode condition.
 - [RESET] or [LIGHT] and [SET] + Power ON. (p. 3)
- 2) Enter SET mode 2.
 - [SET] then [2]. (p. 4)
- 3) Select the TX 5-tone channel to be programmed. (p. 25)
- 4) Program the desired contents of the channel.
- 5) Select the other channels and program the contents.
- 6) To exit SET mode 2, push [RESET].

REFERENCE

The other 2 functions described below can be programmed in each TX 5-tone channel using the EX-704 DATA PROGRAMMER version 3.0.

- ID out
- ABC display

3-4 RX 5-tone channel data

- 1) Enter dealer SET mode condition.
 - [RESET] or [LIGHT] and [SET] + Power ON. (p. 3)
- 2) Enter SET mode 4.
 - [SET] then [4]. (p. 4)
- 3) Select the RX 5-tone channel to be programmed. (p. 29)
- 4) Program the desired contents of the channel.
- 5) Select the other channels and program the contents.
- 6) To exit SET mode 4, push [RESET].

REFERENCE

The other functions described below can be programmed in each RX 5-tone channel using the EX-704 DATA PROGRAMMER version 3.0.

- ABC out
- Bell display
- Beep out
- EXC out
- Auto scan
- ID decode
- Decode action
- Auto TX
- ID (Rch 1 only)

3-5 Answer back channel data

- 1) Enter dealer SET mode condition.
 - [RESET] or [LIGHT] and [SET] + Power ON. (p. 3)
- 2) Enter SET mode 5.
 - [SET] then [5]. (p. 4)
- 3) Select the answer back channel to be programmed.

- 4) Program the desired contents of the channel.
- 5) Select the other channels and program the contents.
- 6) To exit SET mode 5, push [RESET].

3-6 Channel combining

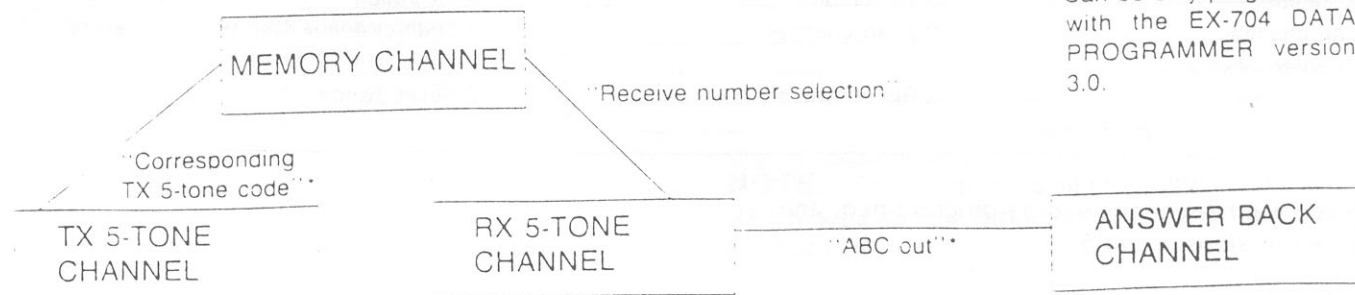

*Can be only programmed with the EX-704 DATA PROGRAMMER version 3.0.

4-1 Operating chart

This section explains only transceiver action; it does not explain programming. Activation of functions is possible or not possible depending on function programming. Use this chart to instruct users about operation.

RECEIVING

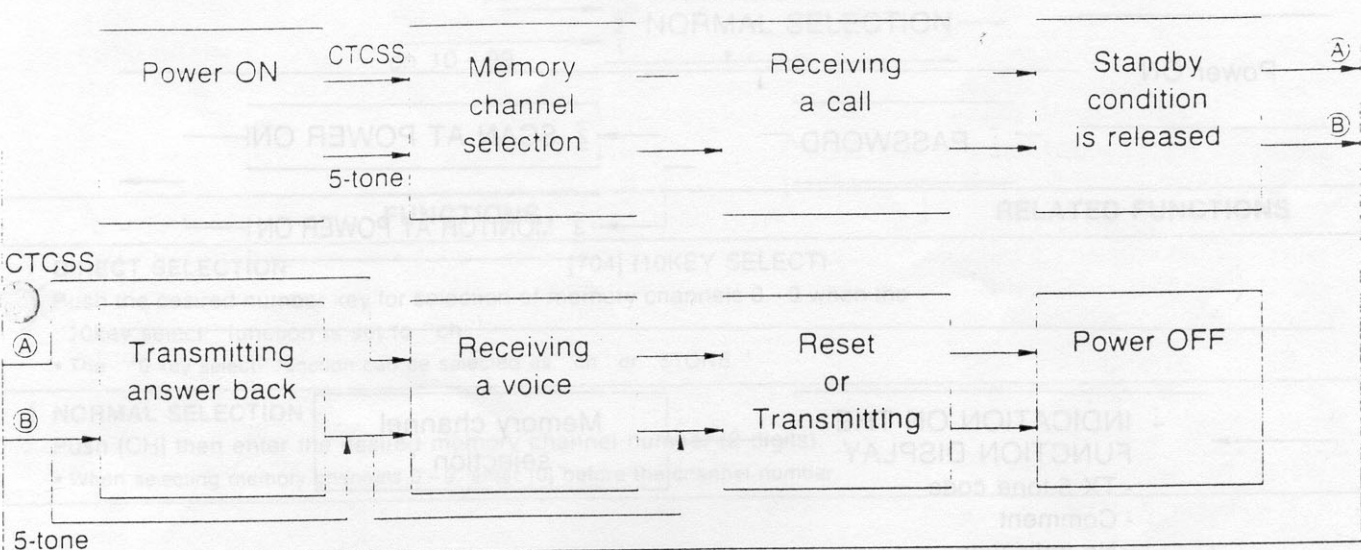

TRANSMITTING

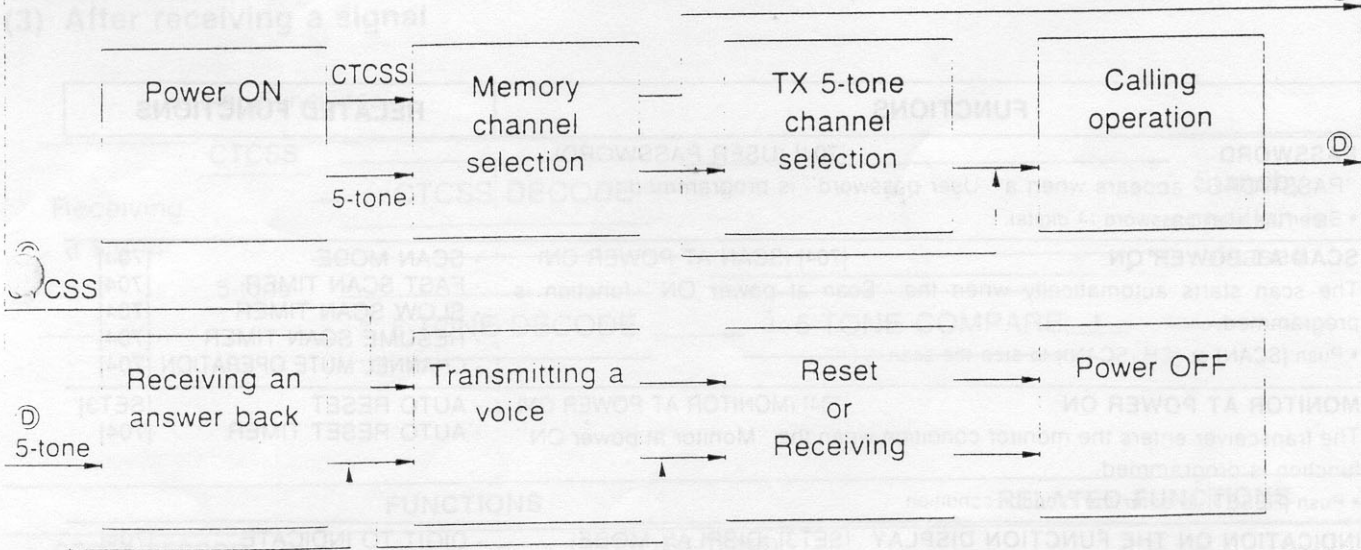

4-2 Mark description

The following marks are used in this section. The meaning of each mark is as follows:

[704] : The function cannot be programmed and canceled with the transceiver, but can be programmed and canceled with the EX-704 DATA PROGRAMMER version 3.0.

[SET1] : The function can be programmed and canceled in dealer SET mode 1.

[SET2] : The function can be programmed and canceled in dealer SET mode 2.

[SET3] : The function can be programmed and canceled in dealer SET mode 3.

[SET4] : The function can be programmed and canceled in dealer SET mode 4.

[SET5] : The function can be programmed and canceled in dealer SET mode 5.

4-3 Receiving

(1) After power on

The transceiver enters the reset condition in OPERATING mode.

- The last used memory channel number appears on the left side of the function display.

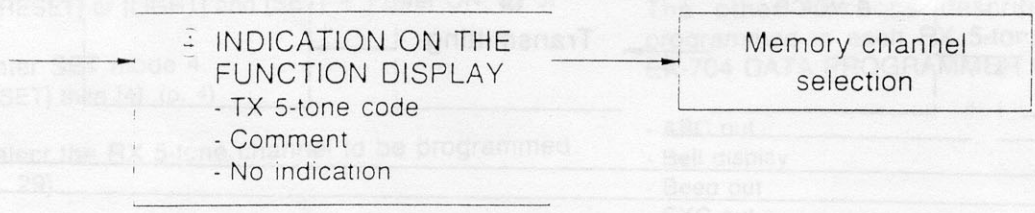
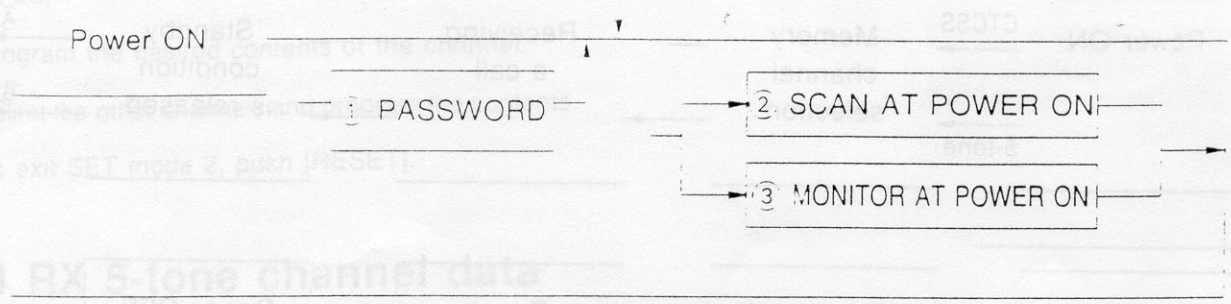

FUNCTIONS		RELATED FUNCTIONS
1	PASSWORD [704] (USER PASSWORD) "PASSWORD" appears when a "User password" is programmed. • Enter the user password (4 digits).	
2	SCAN AT POWER ON [704] (SCAN AT POWER ON) The scan starts automatically when the "Scan at power ON" function is programmed. • Push [SCAN] or [CH + SCAN] to stop the scan.	- SCAN MODE [704] - FAST SCAN TIMER [704] - SLOW SCAN TIMER [704] - RESUME SCAN TIMER [704] - CHANNEL MUTE OPERATION [704]
3	MONITOR AT POWER ON [704] (MONITOR AT POWER ON) The transceiver enters the monitor condition when the "Monitor at power ON" function is programmed. • Push [RESET] to enter the monitor condition.	- AUTO RESET [SET3] - AUTO RESET TIMER [704]
4	INDICATION ON THE FUNCTION DISPLAY [SET3] (DISPLAY MODE) - When CTCSS memory channel is displayed: Only a memory channel number appears. - When a 5-tone memory channel or a 5-tone - CTCSS memory channel is displayed: A memory channel number and TX 5-tone code appears when "Display mode" is set to "CODE". A memory channel number and comment appears when "Display mode" is set to "COMMENT".	- DIGIT TO INDICATE [704] - COMMENT [SET2]

(2) Memory channel selection

• See p. 12 for channel selecting operation.

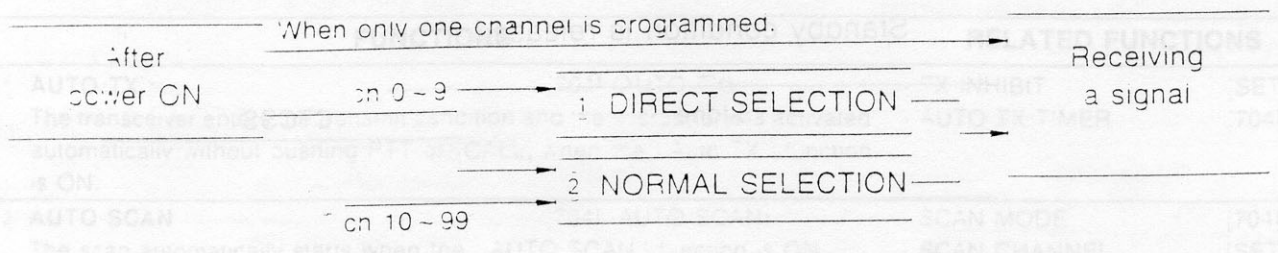

FUNCTIONS	RELATED FUNCTIONS
<p>1 DIRECT SELECTION [704] (10KEY SELECT) Push the desired number key for selection of memory channels 0 ~ 9 when the "10key select" function is set to "ch." • The "10 key select" function can be selected as "ch" or "STONE."</p>	<p>- 2-TONE DATA [704] - 3-TONE DATA [704] - TX INHIBIT [SET3]</p>
<p>2 NORMAL SELECTION Push [CH] then enter the desired memory channel number (2 digits). • When selecting memory channels 0 ~ 9, enter [0] before the channel number.</p>	<p>- DIGIT TO INDICATE [704] - DIGIT TO DECODE [704] - STATUS TIME [SET4] - TUNE ID [704] - BELL INDICATION [704]</p>

(3) After receiving a signal

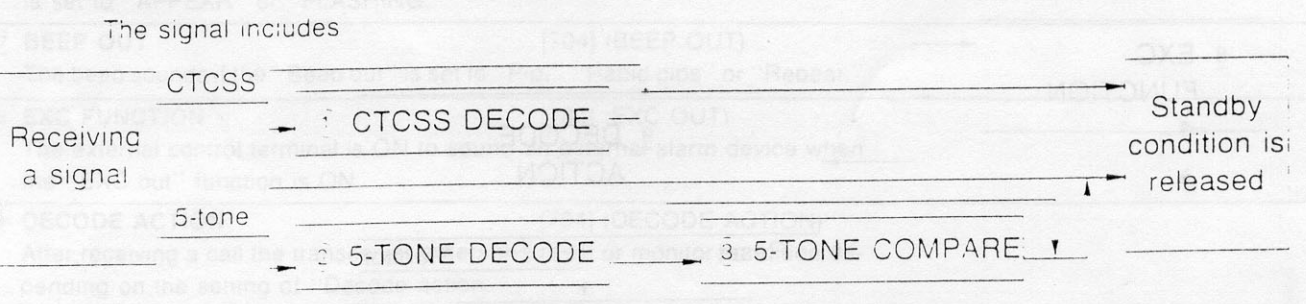

FUNCTIONS	RELATED FUNCTIONS
<p>1 CTCSS DECODE [SET1] (RX TONE) If the received signal includes a CTCSS tone, the CTCSS tone is decoded and is compared with the tone that is programmed in the "RX tone." • When the decoded CTCSS tone is matched with the tone that is programmed in "RX tone," standby is released. • If the "RX tone" has not been programmed, standby is released.</p>	<p>- DIGIT TO DECODE [704] - WAIT TIME ID [704]</p>
<p>2 5-TONE DECODE If the received signal includes a 5-tone code, the 5-tone code is decoded. • If no digits are indicated in "Digit to decode," standby is released.</p>	<p>- RX 5-TONE CHANNEL NUMBER [SET4] - RX 5-TONE CODE [SET4]</p>
<p>3 5-TONE COMPARE [SET1] (R-NR SELECTION) The decoded 5-tone code is compared to the RX 5-tone codes programmed in "Receive number selection." If the decoded 5-tone code is matched to one of the programmed RX 5-tone codes, standby is released.</p>	<p>- RX 5-TONE CHANNEL NUMBER [SET4] - RX 5-TONE CODE [SET4]</p>

(4) After standby condition is released

4-3 Receiving
 (1) After power on

Standby condition is released

5-tone

CTCSS

1 AUTO TX

2 AUTO SCAN

3 ANSWER BACK

6 BELL INDICATION

4 DECODED 5-TONE INDICATION

5 ID CODE INDICATION

7 BEEP OUT

8 EXC FUNCTION

9 DECODE ACTION

Reset

Monitor

10 AUTO RESET

Waiting for the next signal (Standby)

Voice receiving

Push [RESET]

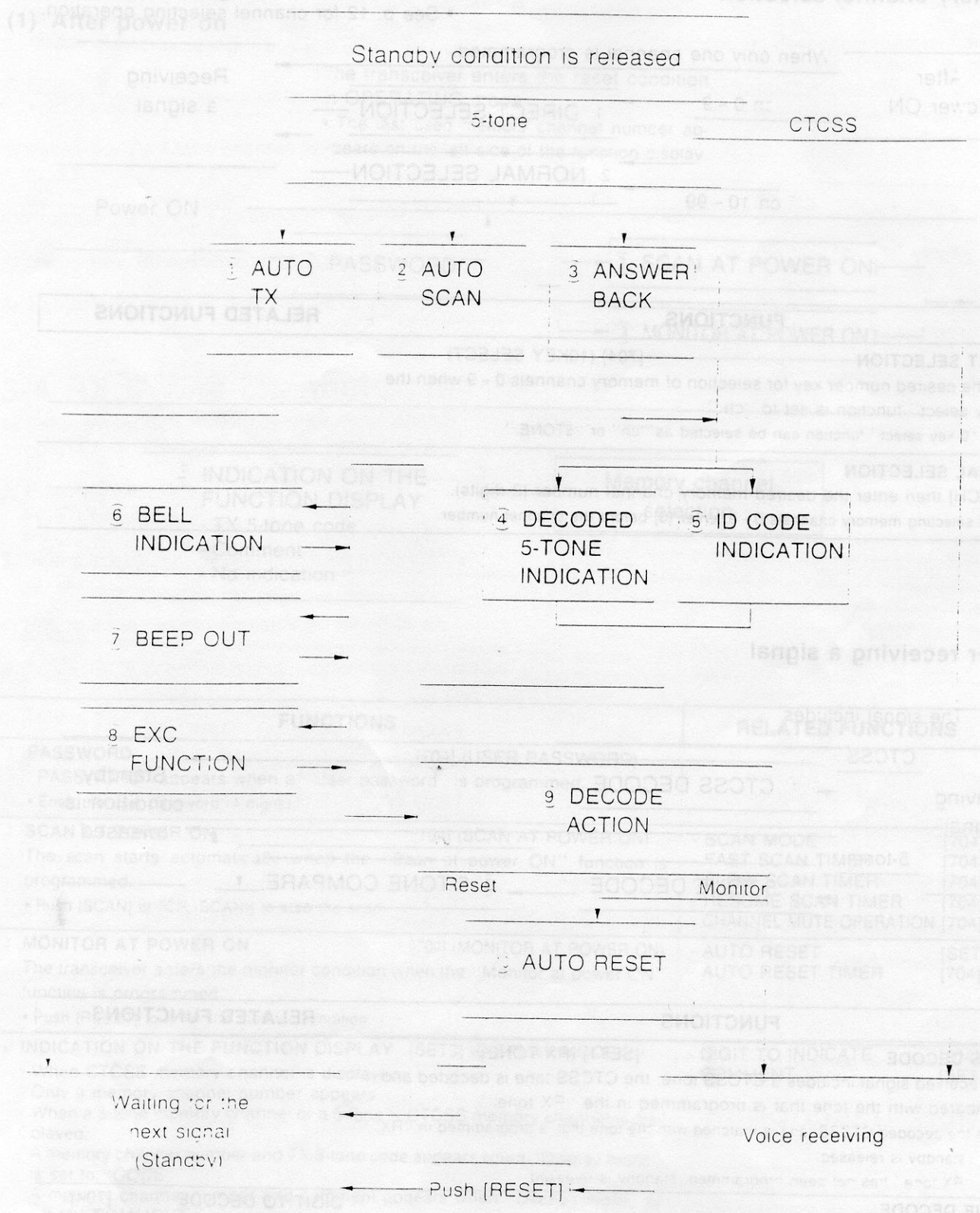

(2) Calling operation (Only for 5-tone memory channels and 5-tone CTCSS)

FUNCTIONS		RELATED FUNCTIONS
1	AUTO TX The transceiver enters the transmit condition and the microphone is activated automatically without pushing PTT or [CALL] when the "Auto TX" function is ON.	[704] (AUTO TX) - TX INHIBIT [SET1] - AUTO TX TIMER [704]
2	AUTO SCAN The scan automatically starts when the "AUTO SCAN" function is ON.	[704] (AUTO SCAN) - SCAN MODE [704] - SCAN CHANNEL [SET1] - FAST SCAN TIMER [704] - SLCW SCAN TIMER [704] - RESUME SCAN TIMER [704]
3	ANSWER BACK The programmed answer back code is automatically transmitted if the "ABC out" function is set to "ABC1," "ABC2" or "ABC3."	[704] (ABC OUT) - ABCh 1 TONE DATA [704] - ABCh 2 TONE DATA [704] - ABCh 3 TONE DATA [704] - TX INHIBIT [SET1]
4	DECODED 5-TONE CODE INDICATION The decode 5-tone code appears when the other functions (1, 2 and 3) are OFF.	[704] (ID DECODE) - DIGIT TO INDICATE [704] - DIGIT TO DECODE [704] - STATUS DIGIT [SET4]
5	ID CODE INDICATION If the "ID decode" function is ON and the received signal also includes an ID code, the decoded ID code is displayed. • The decoded 5-tone code may be displayed instead of the ID code depending on the setting of the "ID out" function.	[704] (ID DECODE) - ID OUT [704]
6	BELL INDICATION The bell indicator appears or flashes depending if the "Bell display" function is set to "APPEAR" or "FLASHING."	[704] (BELL DISPLAY)
7	BEEP OUT The beep sounds if the "Beep out" is set to "Pip," "Rapid pips" or "Repeat."	[704] (BEEP OUT)
8	EXC FUNCTION The external control terminal is ON to sound an external alarm device when the "EXC out" function is ON.	[704] (EXC OUT)
9	DECODE ACTION After receiving a call the transceiver enters the reset or monitor condition depending on the setting of "Decode action."	[704] (DECODE ACTION)
10	AUTO RESET After the transceiver enters the monitor condition, the transceiver automatically enters the reset condition. • If you receive a voice after the call signal, set the function OFF.	[SET3] (AUTO RESET) - AUTO RESET TIMER [704]

4-4 Transmitting

(1) TX 5-tone channel selection (Only for 5-tone memory channels and 5-tone + CTCSS memory channels)

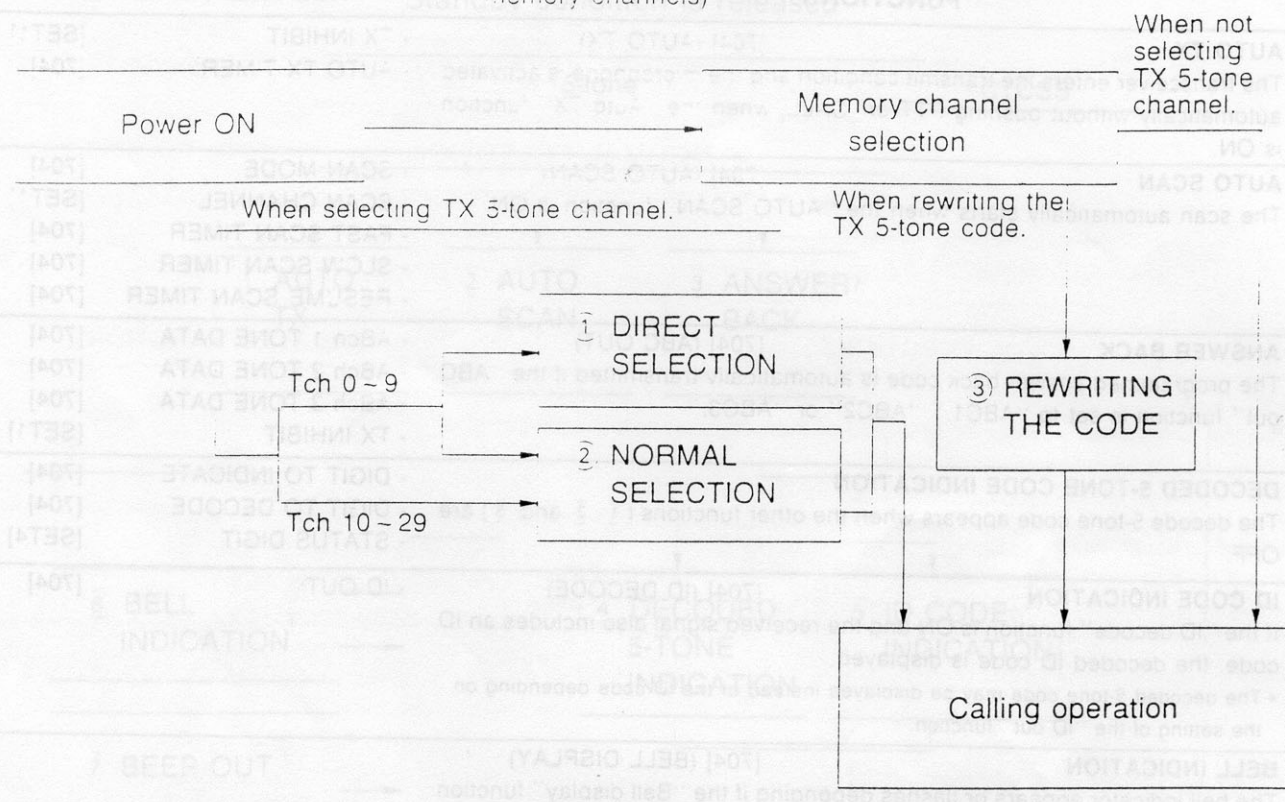

FUNCTIONS	RELATED FUNCTIONS
1 DIRECT SELECTION [704] (10KEY SELECT) Push the desired number key for selection of TX 5-tone channels 0 ~ 9 when the "10 key select" function is set to "5TONE."	
2 NORMAL SELECTION Push [TONE] then enter the desired TX 5-tone channel number (2 digits). • When selecting TX 5-tone channels 0 ~ 9, enter [0] before the channel number.	
3 REWRITING THE CODE [704] (DIGIT TO CHANGE) Push [CLR] then enter the new TX 5-tone code when the "Digit to change" function is programmed to allow rewriting. • To enter the digit /or group codes, use the [G] key.	- DIGIT TO INDICATE [704]

• CHANNEL SELECTING OPERATION

- 1 DIRECT SELECTION : Push 0-9
- 2 NORMAL SELECTION : Push TONE 0-9 0-9

- If this period is longer than 30 sec., the display returns to the previous one.
- The transceiver does not perform transmitting or receiving during this period.

(2) Calling operation (Only for 5-tone memory channels and 5-tone - CTCSS memory channels)

CALLING SIGNAL CONSTRUCTION

1 REPEATER CODE 2 TX 5-TONE CODE 3 ID CODE

Calling signal type

1	2
2	3
3	1 → 2
4	1 → 3
5	2 → 3
6	3 → 2
7	1 → 2 → 3
8	1 → 3 → 2

Push [CALL] to transmit a calling signal.

• If the "TX inhibit" function is ON, transmission is impossible.

<http://www.qsl.net/pe3hmp>

FUNCTIONS		RELATED FUNCTIONS
1	REPEATER CODE [704](LINK TONE REPEATER) The programmed repeater code can be transmitted to access a repeater that requires a 5-tone code when the "Link tone repeater" is ON.	- REPEATER CODE [SET1] - LINK1 TIME [704] - LONG TONE REPEATER [704] - LONG TONE TIME [704] - DURATE TIME [704]
2	TX 5-TONE CODE [704] (LINK TONE CALL) The selected TX 5-tone code can be transmitted when "Link tone call" is ON.	- TX 5-TONE CHANNEL NUMBER[SET2] - TX 5-TONE CODE [SET2] - LINK1 TIME, LINK2 TIME or LINK3 TIME [704] - LONG TONE CALL [704] - LONG TONE TIME [704] - DURATE TIME [704]
3	ID CODE [704] (LINK TONE ID) The programmed ID code can be transmitted if the following conditions are met.	- LINK1 TIME, LINK2 TIME or LINK3 TIME [704] - LONG TONE ID [704] - LONG TONE TIME [704] - DURATE TIME [704]
	1. "LINK TONE ID"....."ON" [704] 2. "ID OUT" "CODE + ID" or "ID + CODE" [704] 3. "Rch 1 TONE CODE"ID code is programmed [SET4] 4. "ID" "ON" [704]	

4 OPERATING INSTRUCTIONS

(3) After calling (Only for 5-tone memory channels and 5-tone + CTCSS memory channels)

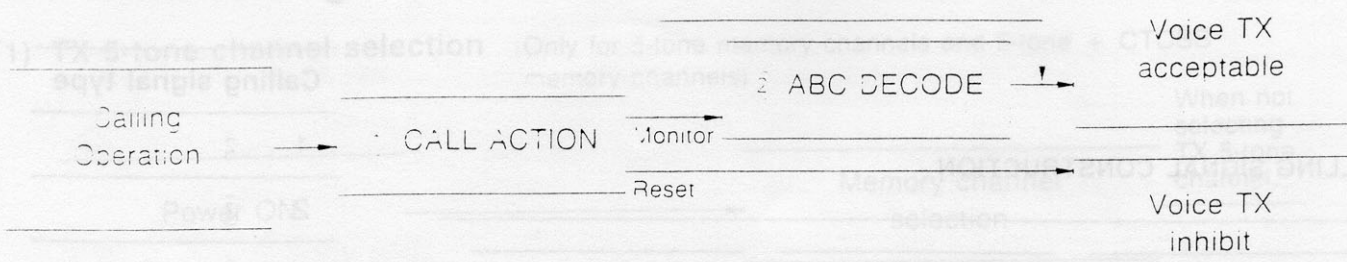

FUNCTIONS		RELATED FUNCTIONS	
1 CALL ACTION	[704] (CALL ACTION)	- AUTO RESET	[SET3]
After calling operation, the transceiver enters the reset or monitor condition depending on the setting of the "call action" function.			
2 ABC DECODE	[SET2] (ABC DECODE)	- ABC DISPLAY	[704]
Answer back code is decoded if the "ABC decode" is ON.			
		- WAIT TIME ABC	[704]

(4) Voice transmission

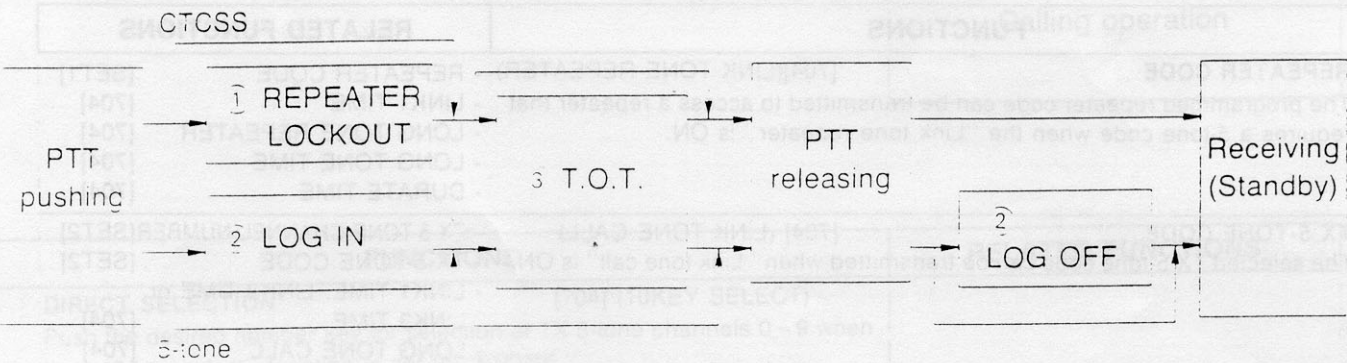

FUNCTIONS		RELATED FUNCTIONS	
REPEATER LOCKOUT	[SET1] (REPEATER LOCKOUT)	- RX TONE	[SET1]
When the operating channel is busy, this function inhibits transmitting. When the received CTCSS tone is matched with the programmed CTCSS tone, the transceiver transmits even if the channel is busy.			
LOG IN/OFF	[704] (LOG IN/OFF)	- LONG TONE ID	[704]
The transceiver sends the programmed ID code at "Log IN" or "Log OFF" depending on the setting of the "Log IN/OFF" function.			
		- LONG TONE TIME	[704]
		- DURATE TIME	[704]
		- ID OUT	[704]
		- Rch 1 TCNE CODE	[SET4]
		- ID	[704]
T.O.T.	[704] (T.O.T.)	- TIME-OUT TIMER	[704]
When the "Time-out timer" function is ON, the transceiver automatically returns to receive at the end of the set transmit period after ID code transmission with no beep, after a beep with no ID code transmission, or after neither.			
		- T.O.T. ALARM	[704]
		- PENALTY TIMER	[704]
* If the beep sounds during final 10 sec. of set period, 5 beeps sound when set			

4-5 Other functions

Rewriting the initial message

The initial message can be replaced with the desired message.

- 1) While the initial message appears, push [CLR].
 - appears.
- 2) Select the first character using the following keys:
 - [CALL]*-[CLR] : Character selection forward
 - [CALL]*-[G] : Character selection backward
- 3) When the first character has been decided, set the character and move the cursor using the following keys:
 - [CALL]*-[7] : Cursor moves to the left
 - [CALL]*-[9] : Cursor moves to the right
- 4) Push [SET] to input the entered characters after all characters have been entered.
- 5) Push [RESET] to exit the setting condition.

* Use [FUNC] for the IC-H21T.

Display mode

The TX 5-tone code or comment can be displayed on the function display while operating in 5-tone memory channels.

Push and hold [SET] for more than 3 sec. to change the display alternately.

Manual monitoring

The monitor condition can be selected manually.

Push [RESET] to alternate between the reset and monitor condition.

NOTE: Entering the monitor condition can be inhibited on the 5-tone memory channels by cloning the data "Reset switch OFF."

Changing dimmer (IC-V210T only)

The display brightness can be changed in OPERATING mode.

Push [SET] to alternate between a high and low brightness level.

NOTE: When voltage is added to the external dimmer control terminal on the rear panel, the dark display is selected. It is possible to couple the car headlight.

Hanger switch (IC-V210T only)

When the user hangs the microphone from the microphone hanger, the transceiver enters the monitor condition.

This function is available on the CTCSS memory channels.

NOTE: When the data of "Hanger switch OFF" has been cloned from the EX-704, this function cannot be used on that channel.

Keyboard backlighting (IC-H21T only)

The function display backlight can be turned ON for night operation, etc.

Push [LIGHT] on the side panel to turn ON and OFF the backlight.
• The backlight is automatically turned OFF after 10 sec.

Keyboard lock (IC-H21T only)

The keyboard lock function prevents the transceiver from changing the memory and TX 5-tone channels accidentally.

When this function is activated, only the PTT, [CALL] and [LIGHT] switches can be used.

1) While pushing [FUNC], push [TONE] to activate the function.
• The lock indicator appears.

2) To cancel the function, while pushing [FUNC], push [TONE] again.

NOTE: The function is not canceled when power turns OFF.

Comment scroll (IC-H21T only)

The function display of the IC-H21T can indicate only the first 5 characters for comment, however, the remaining 8 characters can be indicated using this function.

1) While pushing [FUNC], push [SET] to indicate the next 5 characters.
Keep pushing [FUNC]

2) While holding [FUNC], push [SET] again to indicate the next 3 characters.

3) Release [FUNC].
• The first 5 characters appear.

SET MODE CONDITION

See p. 3 to put the transceiver into the SET mode condition.

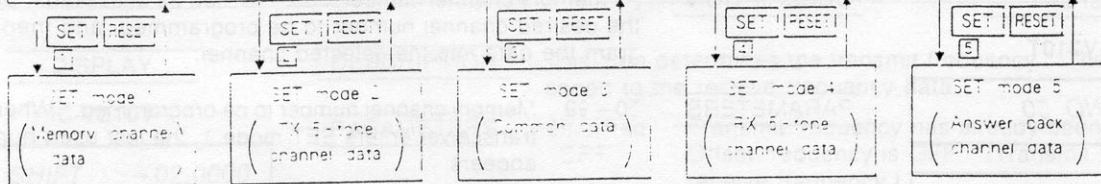

SET mode 1

Memory channel number Selection

- Memory channel 0
- Memory channel 1
- Memory channel 2
- ...
- Memory channel 99

Channel data programming

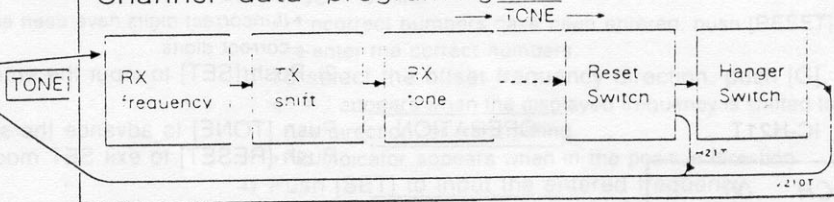

SET mode 2

TX 5-tone channel number selection

- TX 5-tone channel 0
- TX 5-tone channel 1
- TX 5-tone channel 2
- ...
- TX 5-tone channel 29

Channel data programming

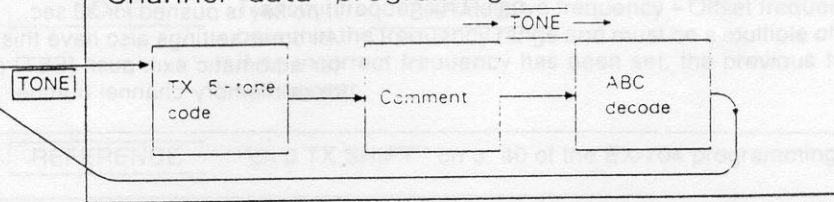

SET mode 3

Display mode

Beep ON/OFF

Auto reset

TONE

TONE

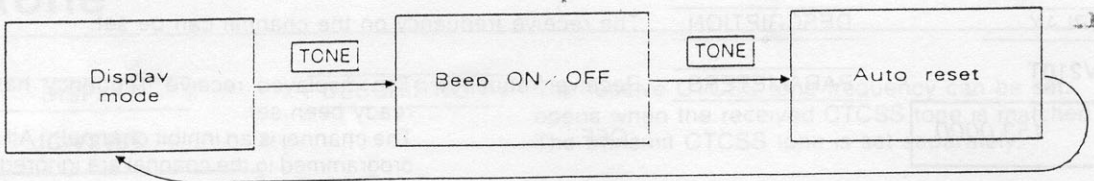

SET mode 4

RX 5-tone channel number selection

- RX 5-tone channel 1
- RX 5-tone channel 2
- RX 5-tone channel 3
- RX 5-tone channel 4

Channel data programming

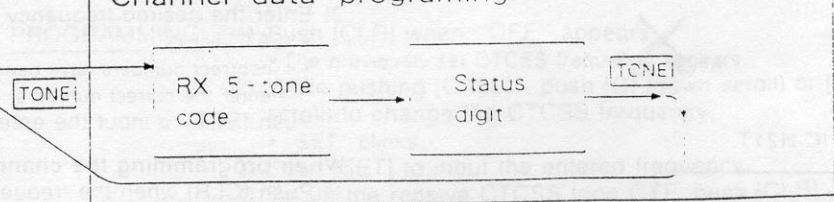

SET mode 5

Answer back channel 1 tone code

Answer back channel 2 tone code

Answer back channel 3 tone code

TONE

TONE

TONE

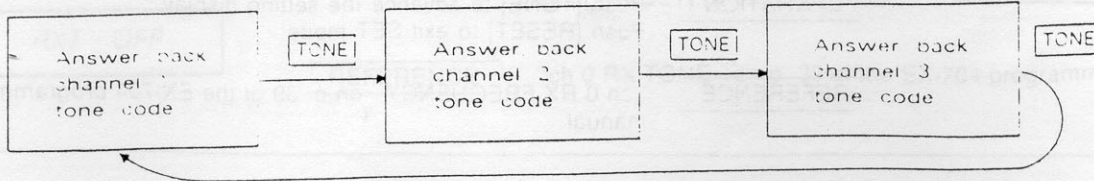

Memory channel number

DISPLAY

IC-V210T

MR CH NO 00

MR CH NO 99

IC-H21T

CH 00

CH 99

DESCRIPTION

All memory channel numbers, 00 ~ 99, can be accessed. Select the desired channel number to be programmed, and then program the data into the selected channel.

PARAMETERS

00 ~ 99 : Memory channel number to be programmed. When the transceiver enters SET mode 1, the last used number appears.

PROGRAMMING

- 1) Enter the desired channel number (2 digits) using the keyboard.
 - "SET" blinks.
 - When entering channels 0 ~ 9, push [0] before entering the channel number.
 - If incorrect digits have been entered, push [RESET] and enter the correct digits.
- 2) Push [SET] to input the entered channel number.

OPERATION

Push [TONE] to advance the setting display.
Push [RESET] to exit SET mode.

NOTE

This item cannot be selected in the user SET mode. In order to change the memory channel number, exit SET mode 1 and change the memory channel number, then enter SET mode 1 again.

REMARKS

If no key is pushed for 30 sec., the transceiver exits SET mode. All other settings also have this timer. In order to re-access after automatic exit, push [SET] and then push [1]. Then, begin from memory channel number setting.

RX frequency

DISPLAY

IC-V210T

RX FREQ. 153.0000

RX FREQ. OFF

IC-H21T

F 153.0000

F OFF

DESCRIPTION

The receive frequency on the channel can be set.

PARAMETERS

Receive frequency : The displayed receive frequency has already been set.
"OFF" : The channel is an inhibit channel. All data programmed in the channel are ignored and inhibited.

PROGRAMMING

- When programming the receive frequency:**
- 1) Push [CLR] when "OFF" appears.
 - The previously set receive frequency appears.
 - 2) Enter the desired frequency (7 digits) with the keyboard.
 - "SET" blinks.
 - If incorrect numbers have been entered, push [RESET], and then re-enter the correct numbers.
 - 3) Push [SET] to input the entered frequency.

When programming the channel as an inhibit channel:

- 1) Push [CLR] when the frequency is displayed.
 - "OFF" appears.
 - This channel has been programmed as an inhibit channel.
- 2) To display the previously set frequency, push [CLR] again.

OPERATION

Push [TONE] to advance the setting display.
Push [RESET] to exit SET mode.

REFERENCE

See "RX FREQUENCY" on p. 39 of the EX-704 programming manual.

TX shift

DISPLAY

IC-V210T

TX SHIFT -02.0000

TX SHIFT OFF

IC-H21T

S. - 02.0000

S. OFF

DESCRIPTION

This data determines the transmit frequency. The data will be added to the receive frequency data.

PARAMETERS

Shift freq. Transmit frequency has already been determined.
 "OFF" Offset frequency is OFF. (Transmit frequency = receive frequency.)

PROGRAMMING

- 1) Push [CLR] when "OFF" appears.
 - The previously set offset frequency appears.
- 2) Enter the required offset frequency (6 digits) with the keyboard.
 - "SET" blinks.
 - If incorrect numbers have been entered, push [RESET], and then re-enter the correct numbers.
- 3) To select the offset frequency direction, push [G].
 - "-" appears when the displayed frequency is shifted to the negative direction for transmitting.
 - No indicator appears when in the positive direction.
- 4) Push [SET] to input the entered frequency.
- 5) To set the data OFF, push [CLR].
 - "OFF" appears.

OPERATION

Push [TONE] to advance the setting display.
 Push [RESET] to exit SET mode.

NOTE

Transmit frequency (Receive frequency + Offset frequency) must be within the frequency range and must be a multiple of the step. If an incorrect frequency has been set, the previous frequency will appear.

REFERENCE

"ch 0 TX SHIFT" on p. 40 of the EX-704 programming manual.

RX tone

DISPLAY

IC-V210T

RX TONE 88.5

RX TONE OFF

IC-H21T

RXT 88.5

RXT OFF

DESCRIPTION

The receive CTCSS tone frequency can be set. The squelch opens when the received CTCSS tone is matched to this tone. The transmit CTCSS tone is set separately.

PARAMETERS

CTCSS frequency : The displayed receive CTCSS tone frequency has already been set.
 "OFF" : Receive CTCSS tone is OFF.

PROGRAMMING

- 1) Push [CLR] when "OFF" appears.
 - The previously set CTCSS frequency appears.
- 2) While pushing [CALL]*, push [G] (down scroll) or [CLR] (up scroll) to change the CTCSS frequency.
 - "SET" blinks.
- 3) Push [SET] to input the entered frequency.
- 4) To set the receive CTCSS tone OFF, push [CLR].
 - Use [FUNC] for the IC-H21T

OPERATION

Push [TONE] to advance the setting display.
 Push [RESET] to exit SET mode.

REFERENCE

"ch 0 RX TONE" on p. 39 of the EX-704 programming manual.

TX tone

DISPLAY	DESCRIPTION
IC-V210T	The transmit CTCSS tone frequency can be set. The set CTCSS tone is transmitted. The receive CTCSS tone is set separately.
TX TONE 88.5	PARAMETERS CTCSS frequency : The displayed transmit CTCSS tone frequency has already been set. "OFF" : Transmit CTCSS tone is OFF.
TX TONE OFF	PROGRAMMING: 1) Push [CLR] when "OFF" appears. • The previously set offset frequency appears. 2) While pushing [CALL]*, push [G] (down scroll) or [CLR] (up scroll) to change the CTCSS frequency. • "SET" blinks. 3) Push [SET] to input the entered frequency. 4) To set the transmit CTCSS tone OFF, push [CLR]. * Use [FUNC] for the IC-H21T.
IC-H21T	
TXT 88.5	OPERATION Push [TONE] to advance the setting display. Push [RESET] to exit SET mode.
TXT OFF	REFERENCE "ch 0 TX TONE" on p. 40 of the EX-704 programming manual.

Receive number selection

DISPLAY	DESCRIPTION
IC-V210T	Each memory channel (operating channel) can access up to 4 different RX 5-tone channels for comparison with the decoded 5-tone code. Select the RX 5-tone channel numbers corresponding to the displayed memory channel. If the decoded 5-tone code is matched to one of the selected RX 5-tone codes, the standby is released.
R-NR 1234	PARAMETERS "1 2 3 4" : The decoded 5-tone code is not compared with the 5-tone code programmed in the RX 5-tone channel. The CTCSS setting is only effective for standby.
R-NR 1234	"1 2 3 4" : The decoded 5-tone code is compared with only Rch 1 and the Rch 3 of the 5-tone code programmed in the RX 5-tone channel.
IC-H21T	"1 2 3 4" : The decoded 5-tone is compared with 5-tone codes programmed in all 4 RX 5-tone channels.
R-NR1234	PROGRAMMING: 1) Push the keys of the required numbers (1 - 4). • Blinking numbers are activated for comparison. Non-blinking numbers are deactivated for comparison. 2) To cancel the numbers, push the key of the required blinking numbers.
R-NR1234	OPERATION Push [TONE] to advance the setting display. Push [RESET] to exit SET mode.
	NOTE When no RX 5-tone channel is selected (no blinking digits), the 5-tone indication is not displayed during this channel operation as the channel cannot perform 5-tone operation.
	REFERENCE "ch 0 RECEIVE NUMBER SELECTION" on p. 50 of the EX-704 programming manual.

Long tone

DISPLAY

IC-V210T

LONG 

LONG 123 OFF

IC-H21T





LONG 

LONG 123

DESCRIPTION

Each tone duration of the 5-Tone code is the same. However, the first tone durations can be made longer than the others for repeater operation, etc. The long tones of the repeater code, TX 5-tone code and ID code are set separately.

PARAMETERS

-  : The first tone of the repeater code is made longer.
-  : The first tone of the TX 5-tone code is made longer.
-  : The first tone of the ID code is made longer.
-  : The first tones of all 3 codes are made longer.
- "123 OFF" : No tone is made longer.

PROGRAMMING

- 1) Push the keys of the required numbers (1 ~ 3).
 - 1: Repeater code
 - 2: TX 5-tone code
 - 3: ID code
 - Blinking numbers are activated and made longer. Non-blinking numbers are deactivated and remain the same.
 - If all numbers are deactivated, "OFF" appears.
- 2) To cancel the long tone, push the key of the required blinking numbers.

OPERATION

Push [TONE] to advance the setting display.
Push [RESET] to exit SET mode.

REFERENCE

"ch 0 LONG TONE REPEATER, CALL and ID" on pgs. 47 ~ 48 of the EX-704 programming manual.

Repeater code

DISPLAY

IC-V210T

REP.CODE OFF

REP.CODE 12345 --

IC-H21T

REP. OFF

REP. 12345 --

DESCRIPTION

Some repeaters require a repeater 5-tone code to access before a 5-tone signal in order to prevent them from malfunctioning. Set the required 5-tone code for repeater access. When the repeater does not require a 5-tone code, set "OFF".

PARAMETERS

- "OFF" : The repeater code is not programmed.
- "12345--" : 5-digits of the repeater code. "12345" are programmed.
- "765AB21" : 7-digits of the repeater code. "765AB21" are programmed.

PROGRAMMING

- 1) Push [CLR] when "OFF" appears.
- 2) Push the required digit keys to enter the repeater code.
 - "SET" flashes.
 - To enter the letters "A" ~ "F", while pushing [CALL], push [1] ~ [6].
 - To enter a blank "--" while pushing [CALL], push [0].
 - If incorrect digits have been entered, push [RESET] and enter the correct digits.
- 3) Push [SET] to input the entered code.
- 4) To set the data OFF, push [CLR].
 - Use [FUNC] for the IC-H21T.

OPERATION

Push [TONE] once to advance the setting display.
Push [RESET] to exit SET mode.

REFERENCE

"ch 0 REPEATER CODE" on p. 41 of the EX-704 programming manual.

TX inhibit

DISPLAY

IC-V210T

TX INH. OFF

TX INH. ON

IC-H21T

INH. OFF

INH. ON

DESCRIPTION

When this function is ON, all transmitting commands are ignored on this channel. (e.g. pushing the PTT switch, auto TX function answer back function, etc.)

PARAMETERS

“OFF” The transceiver functions normally.
“ON” The transceiver does not transmit on this channel.

PROGRAMMING

Push [CLR] to turn this function “ON” or “OFF.”

OPERATION

Push [TONE] to advance the setting display.
Push [RESET] to exit SET mode.

REFERENCE

“ch 0 TX INHIBIT” on p. 42 of the EX-704 programming manual.

Scan channel

DISPLAY

IC-V210T

SCAN OFF

SCAN ON

IC-H21T

SCAN OFF

SCAN ON

DESCRIPTION

This function sets this channel as a scan channel or a lockout channel.

PARAMETERS

“OFF” This channel will be skipped when scanning.
“ON” This channel will be monitored when scanning.

PROGRAMMING

Push [CLR] to turn this function “ON” or “OFF.”

OPERATION

Push [TONE] to advance the setting display.
Push [RESET] to exit SET mode.

NOTE

The EX-704 version 3 uses the lockout channel setting instead of the scan channel setting. If “LOCKOUT --- ON” is cloned from the EX-704, the “SCAN” setting in the IC-V210T/H21T is set to “OFF.” If “LOCKOUT --- OFF” is cloned from the EX-704, the “SCAN” setting in the IC-V210T/H21T is set to “ON.”

REMARKS

When this function is turned ON, a dot appears after the channel number in OPERATING mode.

- When “SCAN MODE 0” is programmed by cloning from the EX-704, a dot doesn't appear even if this function is ON.

REFERENCE

“ch 0 LOCKOUT” on p. 42 of the EX-704 programming manual.

Repeater lockout

<p><u>DISPLAY</u></p> <p>IC-V210T</p>	<p><u>DESCRIPTION</u></p> <p>The repeater lockout function provides transmit inhibiting when this channel is busy during operation. If the PTT switch of the transceiver is pushed while this channel is busy, the transceiver does not transmit. When the received CTCSS tone is matched with the programmed tone, the transceiver transmits even if the channel is busy.</p>
<p>REP. L. OUT OFF</p>	<p><u>PARAMETERS</u></p> <p>“OFF” The repeater lockout function is not activated. “ON” The repeater lockout function is activated.</p>
<p>REP. L. OUT ON</p>	<p><u>PROGRAMMING</u></p> <p>Push [CLR] to turn this function “ON” or “OFF.”</p>
<p>IC-H21T</p>	<p><u>OPERATION</u></p> <p>Push [TONE] to advance the setting display. Push [RESET] to exit SET mode.</p>
<p>REP. L. OFF</p>	<p><u>REFERENCE</u></p> <p>“ch 0 REPEATER LOCKOUT” on p. 44 of the EX-704 programming manual.</p>
<p>REP. L. ON</p>	<p><u>REMARKS</u></p> <p>If no key is pushed for 30 sec, the transceiver exits SET mode. All other settings also have this timer. In order to re-access all set automatic exit, push [SET] and then push [2]. Then begin from TX 5-tone channel number setting.</p>

Reset switch

<p><u>DISPLAY</u></p> <p>IC-V210T</p>	<p><u>DESCRIPTION</u></p> <p>This function activates monitor inhibiting or permitting on the selected channel using the [RESET] switch.</p>
<p>RES. SW OFF</p>	<p><u>PARAMETERS</u></p> <p>“OFF” The [RESET] switch does not allow monitoring. “ON” The [RESET] switch allows monitoring.</p>
<p>RES. SW ON</p>	<p><u>PROGRAMMING</u></p> <p>Push [CLR] to turn this function “ON” or “OFF.”</p>
<p>IC-H21T</p>	<p><u>OPERATION</u></p> <p>Push [TONE] to advance the setting display. Push [RESET] to exit SET mode.</p>
<p>RSET OFF</p>	<p><u>REFERENCE</u></p> <p>“ch 0 RESET SWITCH” on p. 45 of the EX-704 programming manual.</p>
<p>RSET ON</p>	<p><u>OPERATION</u></p> <p>Push [TONE] to advance the setting display. Push [RESET] to exit SET mode.</p>
	<p><u>NOTE</u></p> <p>TX 5-TONE data can be programmed at the call, but 5-tone</p>

Hanger switch (IC-V210T only)

DISPLAY

IC-V210T

HANG SW	OFF
---------	-----

HANG SW	ON
---------	----

DESCRIPTION

When an operator hangs the microphone from the microphone hanger, the monitor function is activated. This is called the hanger switch.

PARAMETER

“OFF” : The hanger switch is not activated for use.
 “ON” : The hanger switch is activated for use.

PROGRAMMING

Push [CLR] to turn this function “ON” or “OFF.”

OPERATION

Push [TONE] to return to the first setting display.
 Push [RESET] to exit SET MODE 1.

NOTE

This function is only available on the CTCSS memory channels.

REFERENCE

“ch 0 HANGER SWITCH” on p. 45 of the EX-704 programming manual.

Comment

TX 5-tone channel number

DISPLAY

IC-V210T

T5TONE CH 00

T5TONE CH 29

DESCRIPTION

All TX 5-tone channel numbers, 0 ~ 29, can be accessed. Select the desired channel number to be programmed, and then program the data into the selected channel.

PARAMETERS

00 ~ 29 TX 5-tone channel number to be programmed. When the transceiver enters SET mode 2, the last used number appears.

PROGRAMMING:

- 1) Enter the desired channel number (2 digits) using the keyboard.
 - "SET" blinks.
 - When entering channels 0 ~ 9, push [0] before entering the channel number.
 - If incorrect digits have been entered, push [RESET] and enter the correct digits.
- 2) Push [SET] to input the entered channel number.

IC-H21T

T5TONE00

T5TONE29

OPERATION

Push [TONE] to advance the setting display.
Push [RESET] to exit SET mode.

REMARKS

If no key is pushed for 30 sec, the transceiver exits SET mode. All other settings also have this timer. In order to re-access after automatic exit, push [SET] and then push [2]. Then begin from TX 5-tone channel number setting.

TX 5-tone code

DISPLAY

IC-V210T

TX. CODE OFF

TX. CODE 12345 --

DESCRIPTION

One TX 5-tone code is programmed into each TX 5-tone channel. Up to 7 digits of a TX 5-tone code can be programmed.

PARAMETERS

- "OFF" The TX 5-tone code is not programmed.
- "12345--" 5-digits of the TX 5-tone code. "12345" are programmed.
- "765AB21" 7-digits of the TX 5-tone code. "765AB21" are programmed.

PROGRAMMING

- 1) Push [CLR] when "OFF" appears.
- 2) Push the required digit keys to enter the 5-tone code.
 - "SET" blinks.
 - To enter the letters "A" ~ "F" while pushing [CALL], push [1] ~ [6].
 - To enter a blank "--" while pushing [CALL], push [0].
 - If incorrect digits have been entered, push [RESET] and enter the correct digits.
- 3) Push [SET] to input the entered code.
 - 1) To set the data "OFF," push [CLR].
 - Use [FUNC] for the IC-H21T.

IC-H21T

T. OFF

T.12345 --

OPERATION

Push [TONE] once to advance the setting display.
Push [RESET] to exit SET mode.

NOTE

TX 5-tone data can be programmed in this part, but 5-tone ON/OFF in each memory channel is determined by the programming in the "Receive number selection" (p. 20).

REFERENCE

Check "TONE CODE" on p. 52 of the EX-704 programming manual.

Comment

DISPLAY	DESCRIPTION
IC-V210T	Indication of the comment instead of the transmit 5-tone code is possible. Up to 13 characters can be programmed in each TX 5-tone channel for a comment.
C. OFF	PARAMETERS "OFF" : Comment is OFF and no indication is displayed on the comment display.
C. XXXXXX	Comment : This comment is displayed instead of the TX 5-tone code. : No comment has been programmed.
IC-H21T	PROGRAMMING:
C. OFF	1) Push [CLR] when "OFF" appears.
C. XXXXX	2) Select the desired character using the following keys: - [CALL]*-[CLR] : Character selection forward - [CALL]*-[G] : Character selection backward
	3) Once the the first character has been entered, set the character and move the cursor using the following keys: - [CALL]*-[7] : Cursor moves to the left - [CALL]*+[9] : Cursor moves to the right
	4) Push [SET] to input the new comment.
	5) To turn this function "OFF," push [CLR]. · Use [FUNC] for the IC-H21T.
	OPERATION : Push [TONE] to advance the setting display. Push [RESET] to exit SET mode.
	REFERENCE : "Tch 0 COMMENT" on p. 53 of the EX-704 programming manual.

ABC decode

DISPLAY	DESCRIPTION
IC-V210T	The answer back code from the connected station can be decoded. This function is set whether the transceiver decodes the answer back code or not. When the transceiver decodes the answer back code, the answer back code is displayed on the function display.
ABC DEC. OFF	PARAMETER "OFF" : The answer back code is not decoded. "ON" : The answer back code is decoded.
ABC DEC. ON	PROGRAMMING: Push [CLR] to turn the data "ON" or "OFF."
IC-H21T	OPERATION : Push [TONE] to return to the first setting display. Push [RESET] to exit SET mode.
ABC.D. OFF	NOTE : The display of the decoded answer back code (ABC display) can be set only by the EX-704. If the ABC display is set to " - - " (no digit indication), the decoded answer back code is not displayed even when the answer back decode is set to "ON." See p. 54 of programming manual of the EX-704 for details.
ABC.D. ON	REFERENCE : "Tch 0 ABC DECODE" on p. 53 of the EX-704 programming manual.

Display mode

DISPLAY

IC-V210T

DISP.MODE CODE

DISP.MODE COMMENT

IC-H21T

DSP CODE

DSP COMM

DESCRIPTION

This function determines the default setting of the display showing the programmed comment or the TX 5-tone code.

PARAMETERS

"CODE" : The display shows the TX 5-tone code.
 "COMMENT" : The display shows the comment.

PROGRAMMING

Push [CLR] to turn the function "CODE" or "COMMENT."

OPERATION

Push [TONE] to advance the setting display.
 Push [RESET] to exit SET mode.

NOTE 1

The indication of the programmed comment or the TX 5-tone code on the function display can also be selected in OPERATING mode. However the default setting can be performed only in SET mode.

NOTE 2

This data cannot be cloned either from the EX-704 or to the EX-704.

REMARKS

If no key is pushed for 30 sec. the transceiver exits SET mode. All other settings also have this timer. To re-access after automatic exit, push [SET] and then push [3]. Then begin from Comment ON/OFF setting.

NOTE

This data cannot be cloned either from the EX-704 or to the EX-704.

Beep ON/OFF

DISPLAY

IC-V210T

BEEP OFF

BEEP ON

IC-H21T

BEEP OFF

BEEP ON

DESCRIPTION

This function sounds a beep when a key on the keyboard is pushed each time. Only this beep can be turned OFF.

PARAMETERS

"OFF" : The beep function is not activated.
 "ON" : The beep function is activated.

PROGRAMMING

Push [CLR] to turn the function "ON" or "OFF."

OPERATION

Push [TONE] to advance the setting display.
 Push [RESET] to exit SET mode.

NOTE

This data cannot be cloned either from the EX-704 or to the EX-704.

Auto reset

DISPLAY

IC-V210T

AUTO RES. OFF

AUTO RES. ON

IC-H21T

A.RES. OFF

A.RES. ON

DESCRIPTION

This function moves the transceiver into the reset condition. After 15 seconds of neither receiving a signal nor transmitting, the transceiver enters the reset condition automatically.

PARAMETERS

"OFF" The auto reset function is not activated.
"ON" The auto reset function is activated.

PROGRAMMING

Push [CLR] to turn the function "ON" or "OFF."

OPERATION

Push [TONE] to return to the first display.
Push [RESET] to exit SET mode.

NOTE 1

When the transceiver enters the reset condition as a result of this function, a beep tone is emitted.

NOTE 2

The time length of this function can be changed using the EX-704. See p. 34 of the EX-704 programming manual "AUTO RESET TIMER" for details.

NOTE 3

This data (ON/OFF) cannot be cloned either from the EX-704 or to the EX-704.

figib autst

RX 5-tone channel number

DISPLAY

IC-V210T

R5TONE CH 1

R5TONE CH 4

DESCRIPTION

Both the IC-V210T and the IC-H21T have 4 RX 5-tone channels. All channel numbers can be accessed. Select the desired channel number to be programmed, and then begin to program the data into the selected channel.

PARAMETERS

1 - 4 RX 5-tone channel number to be programmed. When the transceiver enters SET mode 4, the last used number appears.

PROGRAMMING

Input the desired channel number using the keyboard (1 - 4).

OPERATION

Push [TONE] to advance the setting display.
Push [RESET] to exit SET mode.

IC-H21T

R5TONE 1

R5TONE 4

REMARKS

If no key is pushed for 30 sec. the transceiver exits SET mode. All other settings also have this timer. In order to re-access after automatic exit, push [SET] and then push [4]. Then begin from RX 5-tone channel number setting.

<http://www.qsl.net/pe3hmp>

RX 5-tone code

DISPLAY

IC-V210T

RX. CODE OFF

RX. CODE 12345 --

DESCRIPTION

One RX 5-tone code is programmed into each RX 5-tone channel. Up to 7 digits of an RX 5-tone code can be programmed.

PARAMETERS

"OFF" The RX 5-tone code is not programmed.
"12345 --" 5-digits of the RX 5-tone code. "12345" are programmed.
"765AB21" 7-digits of the RX 5-tone code. "765AB21" are programmed.

PROGRAMMING

- 1) Push [CLR] when "OFF" appears.
- 2) Push the required digit keys to enter the 5-tone code.
 - "SET" blinks
 - To enter the digits "A" - "F" while pushing [CALL], push [1] - [6].
 - To enter a blank "--" while pushing [CALL], push [0].
 - If incorrect digits have been entered, push [RESET] and enter the correct digits.
- 3) Push [SET] to input the entered code.
- 4) To set the data "OFF," push [CLR].
Use [FUNC] for the IC-H21T

IC-H21T

R. OFF

R.12345 --

OPERATION

Push [TONE] once to advance the setting display.
Push [RESET] to exit SET mode.

REFERENCE

"Rch 1 TONE CODE" on p. 56 of the EX-704 programming manual.

Status digit

DISPLAY

IC-V210T

STATUS D. 1234567

STATUS D. 1234567

IC-H21T

S.1234567

S.1234567

DESCRIPTION

When the correct 5-tone code has been detected and decoded, the desired digits of the 5-tone code are displayed.

PARAMETERS

"1 2 3 4 5 6 7": No digit of the decoded 5-tone code is displayed.

"1 2 3 4 5 6 7": Only the 4th and 5th digits of the decoded 5-tone code are displayed.

PROGRAMMING

- 1) Push the keys of the required digits (1 ~ 7).
 - Blinking digits are activated and displayed. Non-blinking digits are deactivated and not displayed.
- 2) To deactivate, push the keys of the required blinking digits.

OPERATION

Push [TONE] to return to the first setting display.
Push [RESET] to exit SET mode.

NOTE

The digits that are designated as status digits are not compared with the RX 5-tone codes.

REFERENCE

"Rch 1 STATUS DIGIT" on p. 60 of the EX-704 programming manual.

Answer back code 1

DISPLAY

IC-V210T

ABC.CODE1 OFF

ABC.CODE1 12345 --

DESCRIPTION

This mode allows you to program the answer back codes (5-tone) into answer back channel 1.

PARAMETERS

- “OFF” : No answer back code is programmed.
- “12345 --” : 5-digits of the answer back code. “12345” are programmed.
- “765AB21” : 7-digits of the answer back code. “765AB21” are programmed.

PROGRAMMING:

- 1) Push [CLR] when “OFF” appears.
- 2) Push the required digit keys to enter the answer back code.
 - “SET” blinks.
 - To enter letters “A” ~ “F” while pushing [CALL]*, push [1] ~ [6].
 - To enter a blank, while pushing [CALL]*, push [0].
 - If incorrect digits have been entered, push [RESET] and enter the correct digits.
- 3) Push [SET] to input the entered code.
- 4) To set the data “OFF,” push [CLR].
 - * Use [FUNC] for the IC-H21T.

IC-H21T

1. OFF

1.12345 --

OPERATION

Push [TONE] to advance the setting display.
Push [RESET] to exit SET mode.

REMARKS

If no key is pushed for 30 sec. the transceiver exits SET mode. All other settings also have this timer. In order to re-access after automatic exit, push [SET] and then push [5]. Then begin from answer back code 1 setting.

NOTE

Digits of the answer back code can be set but selecting an answer back code number for use is impossible in this SET mode. Use the EX-704 DATA PROGRAMMER to select an answer back code number for use. See p. 56 of the EX-704 programming manual for details.

REFERENCE

“ABch 1 TONE CODE” on p. 62 of the EX-704 programming manual.

Answer back code 2

DISPLAY

IC-V210T

ABC.CODE2 OFF

ABC.CODE2 1

IC-H21T

2. OFF

2. 1

DESCRIPTION

This mode allows you to program the answer back code (single tone) into answer back channel 2.

PARAMETERS

“OFF” : No single tone is programmed.
 “1” : The single tone “1” is programmed.
 “A” : The single tone “A” is programmed.

PROGRAMMING:

- 1) Push [CLR] when “OFF” appears.
- 2) Push the required digit key to enter the answer back code.
 - “SET” blinks.
 - To enter the letters “A” ~ “F,” while pushing [CALL]*, push [1] ~ [6].
 - To enter a blank “-” while pushing [CALL]*, push [0].
 - If an incorrect digit has been entered, push [RESET] and enter the correct digit.
- 3) Push [SET] to input the entered code.
- 4) To set the data “OFF,” push [CLR].
 * Use [FUNC] for the IC-H21T.

OPERATION

Push [TONE] to advance the setting display.
 Push [RESET] to exit SET mode.

NOTE

To select an answer back code number for use, see p. 56 of the EX-704 programming manual.

REFERENCE

“ABch 2 TONE CODE” on p. 63 of the EX-704 programming manual.

Answer back code 3

DISPLAY

IC-V210T

ANS.CODE3 OFF

ANS.CODE3 ON

IC-H21T

3. OFF

3. ON

DESCRIPTION

The displayed TX 5-tone code on the function display can be used as the answer back code.

PARAMETERS

“OFF” : The displayed TX 5-tone code is not used as the answer back code.
 “ON” : The displayed TX 5-tone code is used as the answer back code.

PROGRAMMING:

Push [CLR] to turn the data “ON” or “OFF.”

OPERATION

Push [TONE] to return to the first setting display.
 Push [RESET] to exit SET mode.

NOTE

To select an answer back code number for use, see p. 56 of the EX-704 programming manual.

REFERENCE

“ABch 3 TONE CODE” on P. 64 of the EX-704 programming manual.

11-1 IC-V210T installation and connections

(1) Installation

NOTE: DO NOT install the transceiver where hot or cold air will blow directly on it.

- 1) Select a location that can support the weight of the transceiver, and that will not interfere with driving.
- 2) Place the mounting bracket in a suitable location and mark screw holes on the bracket. Be sure all controls and switches are within reach and that the display is within easy view for the driver.

- 3) Drill the holes and mount the bracket as shown in the diagram. Tighten the screws.
- 4) Install the microphone hanger with a microphone hanger cable at the desired position near the transceiver for CTCSS operation. The cable must be grounded.
- 5) Insert the microphone plug into the microphone connector. Then, fix the connector with the supplied screw.

To prevent damage attach the mic cable to the transceiver as shown below.

Vary installation angle for best visibility.

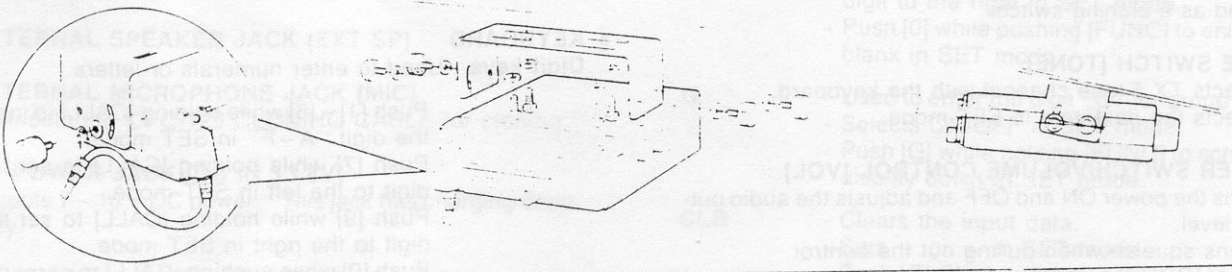

(2) Connections

1 ANTENNA

Connect an antenna with a PL-259 connector.

2 DC POWER CABLE

Be sure the polarities are matched correctly. NEVER connect a 24 V DC battery directly. This may damage the transceiver. For use with AC, the PS-200 AC POWER SUPPLY is available.

3 EXTERNAL ALARM

An external alarm such as a horn can be used to alert an operator when a 5-tone code is received.

4 EXTERNAL DIMMER CONTROL CABLE

The dimmer or the function display can be adjusted remotely. While this cable is receiving 12 V DC, the brightness change. Connect the cable to the headlight switch or another switch of the car.

5 EXTERNAL SPEAKER

An optional external speaker can be used for clearer audio.

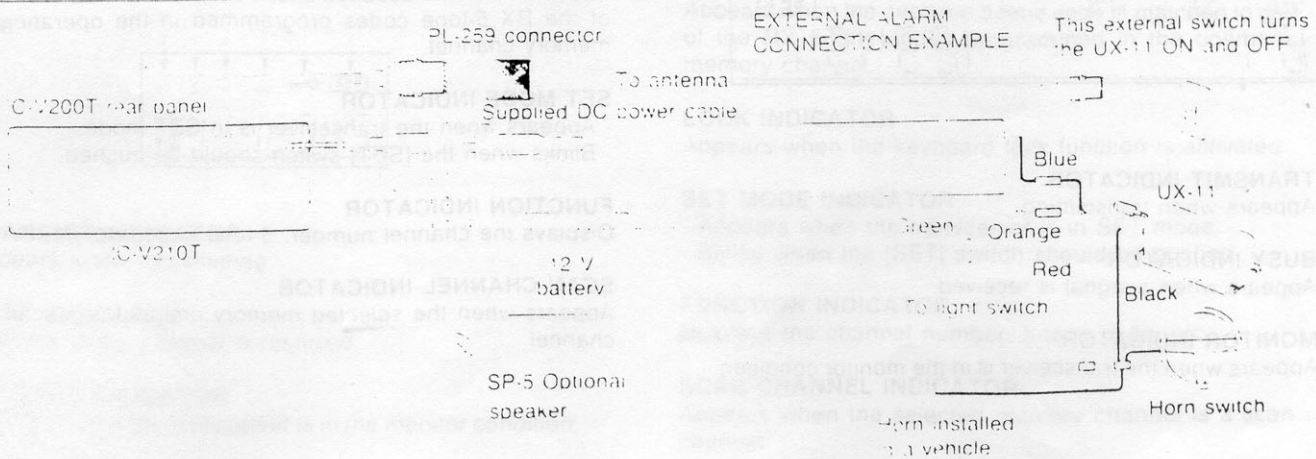

11-2 IC-V210T panel description

(1) Switches and control

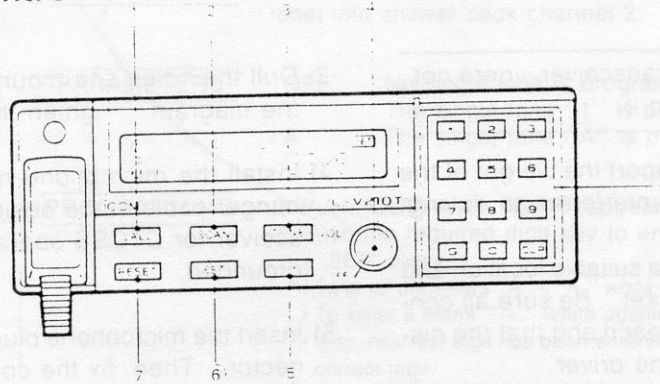

- 1 **CALL SWITCH [CALL]**
 - Transmits 5-tone codes.
 - Used as a function switch in SET mode.
- 2 **SCAN SWITCH [SCAN]**
 - Starts and stops scanning.
 - Used as a cloning switch.
- 3 **TONE SWITCH [TONE]**
 - Selects TX 5-tone channel with the keyboard.
 - Selects the next item in SET mode.
- 4 **POWER SWITCH/VOLUME CONTROL [VOL]**
 - Turns the power ON and OFF and adjusts the audio output level.
 - Opens squelch when pulling out the control.
- 5 **CHANNEL SWITCH [CH]**
 - Selects a memory channel with the keyboard.
- 6 **SET SWITCH [SET]**
 - Adjusts the display brightness.
 - Selects TX 5-tone indication or comment indication when pushing and holding for 4 sec.
 - Selects SET mode when the transceiver is in the SET mode condition.

- 7 **RESET SWITCH [RESET]**
 - Selects the reset or monitor condition.
 - The monitor condition cannot be selected when the reset switch is set to OFF in dealer SET mode.
 - Resets each operation in both OPERATING and SET modes.
- 8 **KEYBOARD**
 - Digit keys** : Used to enter numerals or letters.
 - Push [1] ~ [6] while holding [CALL] to input the digit "A - F" in SET mode.
 - Push [7] while holding [CALL] to set the digit to the left in SET mode.
 - Push [9] while holding [CALL] to set the digit to the right in SET mode.
 - Push [0] while pushing [CALL] to enter the blank in SET mode.
 - G** :
 - Used to enter the digit "G" for group code.
 - Selects ON/OFF in SET mode.
 - Push [G] while holding [CALL] to scroll the display down in SET mode.
 - CLR** :
 - Clears the input data.
 - Sets + or - in SET mode.
 - Push [CLR] while holding [CALL] to scroll the display up in SET mode.

(2) Function display

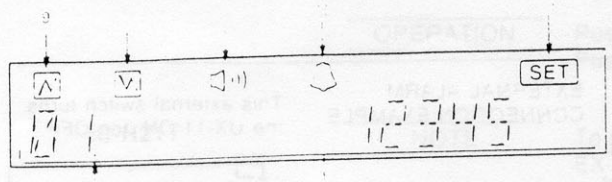

- 1 **TRANSMIT INDICATOR**
 - Appears when transmitting.
- 2 **BUSY INDICATOR**
 - Appears when a signal is received.
- 3 **MONITOR INDICATOR**
 - Appears when the transceiver is in the monitor condition.

- 4 **BELL INDICATOR**
 - Appears when the decoded 5-tone code is matched to one of the RX 5-tone codes programmed in the operating memory channel.
- 5 **SET MODE INDICATOR**
 - Appears when the transceiver is in SET mode.
 - Blinks when the [SET] switch should be pushed.
- 6 **FUNCTION INDICATOR**
 - Displays the channel number, 5-tone code, etc.
- 7 **SCAN CHANNEL INDICATOR**
 - Appears when the selected memory channel is a scan channel.

11-3 IC-H21T panel description

(1) Switches, jacks and control

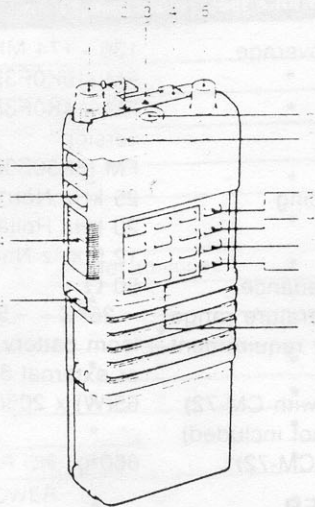

- 1 ANTENNA CONNECTOR
- 2 EXTERNAL SPEAKER JACK [EXT SP]
- 3 EXTERNAL MICROPHONE JACK [MIC]
Connects the OPC-129 CLONING CABLE for cloning.
- 4 DC POWER JACK [DC IN 13.8V]
Accepts 7 ~ 16 V DC power. This jack has charging capability.
- 5 POWER SWITCH/VOLUME CONTROL [VOL]
- 6 AUXILIARY SWITCH [S]
This switch is not used at present.
- 7 TRANSMIT INDICATOR [TX]
- 8 SET SWITCH [SET]
Selects TX 5-tone indication or comment indication.
Scrolls the comment while pushing [FUNC].
- Selects SET mode when the transceiver is in the SET mode condition.
- 9 CHANNEL SWITCH [CH (SCAN)]
- Selects a memory channel with a keyboard.
- Starts scanning while pushing [FUNC].
- Stops scanning.

TONE SWITCH [TONE (LOCK)]

- Selects a TX 5-tone code with a keyboard.
- Activates the keyboard lock function while pushing [FUNC].
- Selects the next item in SET mode.

RESET SWITCH [RESET]

- Selects the reset or monitor condition.
- The monitor condition cannot be selected when the reset switch is set to OFF in dealer SET mode.
- Resets each operation in both OPERATING and SET modes.

KEYBOARD

Digit keys : Used to enter numerals or letters.

- Push [1] ~ [6] while holding [FUNC] to input the digit "A ~ F" in SET mode.
- Push [7] while holding [FUNC] to set the digit to the left in SET mode.
- Push [9] while holding [FUNC] to set the digit to the right in SET mode.
- Push [0] while pushing [FUNC] to enter the blank in SET mode.

G : - Used to enter the digit "G" for group code.
- Selects ON/OFF in SET mode.
- Push [G] while holding [FUNC] to scroll the display down in SET mode.

CLR : - Clears the input data.
- Sets + or - in SET mode.
- Push [CLR] while holding [FUNC] to scroll the display up in SET mode.

LIGHT SWITCH [LIGHT]

PTT SWITCH

CALL SWITCH [CALL]
Transmits 5-tone codes in OPERATING mode.

FUNCTION SWITCH [FUNC]
- Activates the secondary switch functions.
- Used as a cloning switch.
- Used as a function switch in SET mode.

BELL INDICATOR
Appears when the decoded 5-tone code is matched to one of the RX 5-tone codes programmed in the operating memory channel.

LOCK INDICATOR
Appears when the keyboard lock function is activated.

SET MODE INDICATOR
- Appears when the transceiver is in SET mode.
- Blinks when the [SET] switch should be pushed.

FUNCTION INDICATOR
Displays the channel number, 5-tone code, etc.

SCAN CHANNEL INDICATOR
Appears when the selected memory channel is a scan channel.

(2) Function display

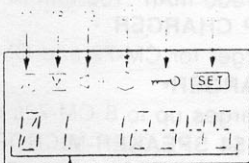

TRANSMIT INDICATOR
Appears when transmitting.

BUSY INDICATOR
Appears when a signal is received.

MONITOR INDICATOR
Appears when the transceiver is in the monitor condition.

11-4 Specifications

(1) IC-V210T

GENERAL

- Frequency coverage : 136 – 174 MHz
(A range is restricted depending on the versions.)
- Mode : FM (16K0F3E) Normal type
FM (14K0F3E) Holland version
FM (8K50F3E) Narrow type
- Channel spacing : 25 kHz Normal type
20 kHz Holland version
12.5 kHz Narrow type
- Antenna impedance : 50 Ω
- Usable temperature range : $-25^{\circ}\text{C} \sim +55^{\circ}\text{C}$
- Power supply requirement : 13.8 V DC $\pm 15\%$
- Dimensions : 140(W) x 50(H) x 182(D) mm
(projections not included)
- Weight : 1.5 kg

TRANSMITTER

- Output power : 25 W Normal type
10 W Low power type

RECEIVER

- Sensitivity : 0.35 μV for 12 dB SINAD
- Squelch sensitivity : 0.32 μV (threshold)
- Audio output power : 3 W with a 4 Ω load
- Audio output impedance : 4 Ω

All stated specifications are subject to change without notice or obligation.

11-5 Options

(1) IC-V210T

- **EM-63 HAND MICROPHONE**
Same type as supplied with the IC-V210T.
- **HM-47 DTMF MICROPHONE**
Hand microphone equipped with a DTMF encoder.
- **MB-26 MOUNTING BRACKET**
Same type as supplied with the IC-V210T.
- **OPC-044A DC POWER CABLE**
Same type as supplied with the IC-V210T.
- **OPC-178 CLONING CABLE**
For a cloning connection between two IC-V210Ts.
- **SP-5 EXTERNAL SPEAKER**
Large size external mobile speaker for high output power.
Max input power: 5 W Input impedance: 4 Ω
- **SP-10 EXTERNAL SPEAKER**
Compact size external mobile speaker.
Max input power: 5 W Input impedance: 4 Ω
- **PS-200 AC POWER SUPPLY**
13.8 V DC/8 A power supply for use the IC-V210T with AC.
- **SM-14 DESKTOP MICROPHONE**
Desktop microphone equipped with a call switch.
- **UX-11 HORN-HONK DRIVER UNIT**
This unit is necessary for a connection to the external alarm device.

(2) IC-H21T

GENERAL

- Frequency coverage : 136 – 174 MHz
- Mode : FM (16K0F3E) Normal type
FM (14K0F3E) Holland version
FM (8K50F3E) Narrow type
- Channel spacing : 25 kHz Normal type
20 kHz Holland version
12.5 kHz Narrow type
- Antenna impedance : 50 Ω
- Usable temperature range : $-25^{\circ}\text{C} \sim +55^{\circ}\text{C}$
- Power supply requirement : Icom battery pack or case
or external 8 – 16 V DC
- Dimensions (with CM-72) : 65(W) x 205(H) x 35(D) mm
(projections not included)
- Weight (with CM-72) : 660 g

TRANSMITTER

- Output power : 5 W (at 13.8 V DC)
2 W (at 8.4 V DC)

RECEIVER

- Sensitivity : 0.35 μV for 12 dB SINAD
- Squelch sensitivity : 0.3 μV (threshold)
- Audio output power : 500 mW
- Audio output impedance : 8 Ω

All stated specifications are subject to change without notice or obligation.

(2) IC-H21T

• BATTERY PACKS AND BATTERY CASES

- | | | | |
|--------|--------------|-----------------|-----------------|
| CM-3G | 8.4 V | 270 mAh | 39 mm (1.5 in) |
| CM-4G | Battery case | | 49 mm (1.9 in) |
| | | for six R6 (AA) | |
| CM-5G | 10.8 V | 450 mAh | 56 mm (2.2 in) |
| CM-5AG | 10.8 V | 450 mAh | 80 mm (3.1 in) |
| CM-7G | 13.2 V | 450 mAh | 80 mm (3.1 in) |
| CM-8G | 8.4 V | 800 mAh | 80 mm (3.1 in) |
| CM-12G | Battery case | | 80 mm (3.1 in) |
| | | for ten R6 (AA) | |
| CM-72 | 8.4 V | 1000 mAh | 75 mm (3.0 in) |
| CM-73 | 13.2 V | 1000 mAh | 109 mm (4.3 in) |

• BM-70E DESKTOP CHARGER

Desktop rapid charger for CM-72 and CM-73.

• BM-75 MULTI-CHARGER

Simultaneously charges up to 6 CM-72s or CM-73s.

• CM-9, EM-46, HM-54 SPEAKER-MICROPHONES

• CP-13 CIGARETTE LIGHTER CABLE WITH NOISE FILTER

For operation or charging with a 12 V battery

• HS-51 HEADSET

• MB-16, MB-16D MOUNTING BRACKETS

MB-16: Hanger-type. MB-16D: Wall-type.

• OPC-129 CLONING CABLE

For a cloning connection between two IC-H21Ts.

• OPC-288 DC POWER CABLE

• ST-10 SHOULDER STRAP

11-6 Data in the transceivers

DATA	IC-V210T			IC-H21T		
	Clone	Dealer	User	Clone	Dealer	User
INITIAL DATA						
Mem No. min-max	•	-	-	•	-	-
Tch No. min-max	•	-	-	•	-	-
COMMON DATA						
IF FREQUENCY	•	-	-	•	-	-
IF FREQUENCY SIGN	•	-	-	•	-	-
POWER SAVER	Not equipped.			•	-	-
SCAN MODE	•	-	-	•	-	-
BEEP	-	•	•	-	•	•
FOKEY SELECT	•	-	-	•	-	-
T.O.T. ALARM	•	-	-	•	-	-
CALL ACTION	•	-	-	•	-	-
SCAN AT POWER ON	•	-	-	•	-	-
MONITOR AT POWER ON	•	-	-	•	-	-
DIGIT TO INDICATE	•	-	-	•	-	-
DIGIT TO CHANGE	•	-	-	•	-	-
DIGIT TO DECODE	•	-	-	•	-	-
USER PASSWORD	•	-	-	•	-	-
DEALER PASSCODE	•	-	-	•	-	-
INITIAL MESSAGE	-	-	-	-	-	-
POWER SAVER OFF TIMER	Not equipped.			•	-	-
POWER SAVER ON TIMER	Not equipped.			•	-	-
TIME-OUT TIMER	•	-	-	•	-	-
FAST SCAN TIMER	•	-	-	•	-	-
SLOW SCAN TIMER	•	-	-	•	-	-
RESUME SCAN TIMER	•	-	-	•	-	-
BURST TIMER	•	-	-	•	-	-
TX MUTE TIMER	•	-	-	•	-	-
RX MUTE TIMER	•	-	-	•	-	-
PENALTY TIMER	•	-	-	•	-	-
EXC TIMER	•	-	-	Not equipped.		
AUTO RESET TIMER	•	-	-	•	-	-
AUTO TX TIMER	•	-	-	•	-	-
LINK1 TIME	•	-	-	•	-	-
LINK2 TIME	•	-	-	•	-	-
LINK3 TIME	•	-	-	•	-	-
LONG TONE TIME	•	-	-	•	-	-
WAIT TIME D	•	-	-	•	-	-
WAIT TIME ABC	•	-	-	•	-	-
DISPLAY MODE	-	•	•	-	•	•
AUTO RESET	-	•	-	-	•	-

DATA	IC-V210T			IC-H21T		
	Clone	Dealer	User	Clone	Dealer	User
MEMORY CHANNEL DATA						
RX FREQUENCY	•	•	-	•	•	-
RX TONE	•	•	-	•	•	-
TX SHIFT	•	•	-	•	•	-
TX TONE	•	•	-	•	•	-
REPEATER CODE	•	•	-	•	•	-
FORMAT	•	-	-	•	-	-
SCAN CHANNEL (LOCKOUT)	•	•	•	•	•	•
TX INHIBIT	•	•	-	•	•	-
LOW POWER	•	-	-	•	-	-
T.O.T.	•	-	-	•	-	-
REPEATER LOCKOUT	•	-	-	•	-	-
TX 5-TONE	•	-	-	•	-	-
RESET SWITCH	•	•	-	•	•	-
HANGER SWITCH	•	•	-	Not equipped.		
CHANNEL MUTE OPERATION	•	-	-	•	-	-
LOG IN/OFF	•	-	-	•	-	-
LONG TONE REPEATER	•	•	-	•	•	-
LONG TONE CALL	•	•	-	•	•	-
LONG TONE ID	•	•	-	•	•	-
LINK TONE REPEATER	•	-	-	•	-	-
LINK TONE CALL	•	-	-	•	-	-
LINK TONE ID	•	-	-	•	-	-
RECEIVE NUMBER SELECTION	•	•	•	•	•	•
DURATION TIME	•	-	-	•	-	-
TX 5-TONE CHANNEL DATA						
TCNE CODE	•	•	•	•	•	•
ID OUT	•	-	-	•	-	-
ABC DECODE	•	•	-	•	•	-
COMMENT	•	•	•	•	•	•
ABC DISPLAY	•	-	-	•	-	-
RX 5-TONE CHANNEL DATA						
TCNE CODE	•	•	•	•	•	•
ABC OUT	•	-	-	•	-	-
BELL DISPLAY	•	-	-	•	-	-
BEEP OUT	•	-	-	•	-	-
EXC OUT	•	-	-	Not equipped.		
AUTO SCAN	•	-	-	•	-	-
ID DECODE	•	-	-	•	-	-
DECODE ACTION	•	-	-	•	-	-
AUTO TX	•	-	-	•	-	-
STATUS DIGIT	•	•	-	•	•	-
ID	•	-	-	•	-	-
ANSWER BACK CHANNEL DATA						
ABCh 1 TONE CODE	•	•	-	•	•	-
ABCh 2 TONE CODE	•	•	-	•	•	-
ABCh 3 TONE CODE	•	•	-	•	•	-

Clone = Cloning from the EX-704 DATA PROGRAMMER, version 3.0
 Dealer = Dealer SET mode
 User = User SET mode

• Applicable
 - Not applicable